

軸 受

MOUNTED UNITS CATALOGUE



In January 1958 Our Company
MINAMIGUCHI BEARING MFG.CO.,LTD.
In Osaka Japan, established by HIROMU MINAMIGUCHI.











Afterwards its production activities has been developed, enlarged and ball bearings commenced to be produced. It has always been our motto "HIGHER QUALITY & LOWER COST" as it is at present, through working hard constantly so as to enable us contribute to the industrial worked as well as to meet with the patronage of our customers.















MOUNTED UNITS CATALOGUE



Technical Information		Pages for refer
		8 ~ 23
1	Feature	8
2	Lubrication	8 ~ 9
3	Tolerances for Mounted Units	9 ~ 14
4	Radial Internal Clearance of Bearings	15
5	Selection of Bearing Size	16 ~ 20
6	Selection of Shafts	20 ~ 21
7	Mounting of Mounted Units on Shafts	21 ~ 22
8	Standard of Set-screws	22
9	Material for Cast Iron Housing	23

Product Information		Pages for refer
		26 ~ 39
	Pillow Blocks Type	
	UCAK 200 Series	26
	UCP 200 Series	27 ~ 28
	UKP 200 Series	29
	UCPA 200 Series	30
	UKPA 200 Series	31
	UCPH 200 Series	32
	Two Bolts Flanged Units Type	
	UCFL 200 Series	33 ~ 34
	UKFL 200 Series	35
	Three Bolts Flanged Units Type	
	UCFB 200 Series	36
	Four Bolts Flanged Units Type	
	UCF 200 Series	37 ~ 38
	UKF 200 Series	39

Product Information		Pages for refer
		40 ~ 54
	Special Flanged Units Type	
	UCFA 200 Series	40
	Flanged Cartridge Units Type	
	UCFC 200 Series	41 ~ 42
	UKFC 200 Series	43
	Take Up Units Type	
	UCT 200 Series	44 ~ 45
	Hanger Units Type	
	UCHA 200 Series	46
	Insert Bearings	
	UC 200 Series	47 ~ 48
	UK 200 Series	49
	SA 200 Series	50
	SB 200 Series	51
	CSA 200 Series	52
	CSB 200 Series	53
	SER 200 Series	54



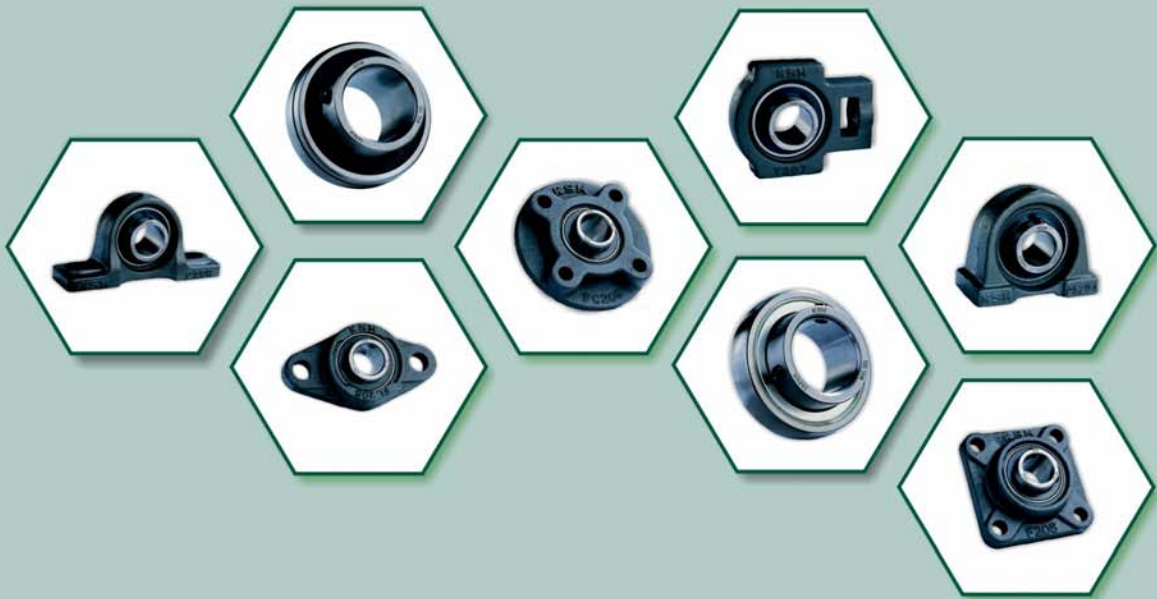

KSM[®]



Technical Information



1. Feature

The Insert Ball Bearings of **KSM** are deep groove ball bearing with wide and narrow inner rings, consisting of insert bearings (SB200, UC200, UK200, SA200, CSA200, CSB200, SER200) and various housings. The types of mounted units are defined according to the different mounting methods of the bearings to shafts: the set-screws type, the adapter type.

The **KSM** housings are mainly casting housings. There are pressed steel plate housings as well align with ease during operation and can be conveniently mounted or dismounted.

The mounted units can operate satisfactorily under working conditions, especially for machines operating in dusty or muddy surroundings. Thus, they are widely used in agricultural, construction and transmission machineries, etc.

There are various types of sealing devices for our products, such as synthetic rubber seals, slinger with synthetic rubber seals and triple lip seals etc.

Sufficient lubricating grease has been put into the bearings during manufacturing, which can act as lubricating as well as rust proof. No more grease is needed to put in during the lubricating period when the bearings operate under normal conditions. Lubricating grease can be added from the fittings when the relubricate bearings operate under hard conditions.

The outer ring of the bearing has spherical outside surface which can be fitted to the concave spherical surface of the housing, and the fit between them can be clearance fit or interference fit according to different conditions. This combination provides self-alignment between the self-contained bearing and the housing, and compensates for a certain alignment errors or flexing of the shaft when the bearing is in operation. This definitely increases the bearing service life.

2. Lubrication

The Insert Ball Bearings of **KSM** generally use CG-2 rust proof lithium based lubricating grease, with physical chemical properties shown in the following Table 2.1. Grease is filled in the Insert Ball Bearings during manufacturing.

Table 2.1 Physical chemical properties of lubricating grease

Density (1/mm)	Without operation	268
	Operated 60 times	260
Dropping point (°C)		128
Mechanical impurities	10-25 μm	within 1000
(pc / gram)	25-75 μm	within 500
	above 75 μm	0
Base oil kinematical Viscosity 40°C est		80.3

The bearings usually operate below the temperature of 120° C (the measuring temperature of the outer rings is 100° C). Grease life reduction has to be taken into account when the bearing continues to operate at a temperature above 70° C. The lowest operating temperature should not be lower than - 30° C.

The permissible speed of rotation is connected with the fit between shaft and bearing. It is recommended that, under normal operating conditions, the fit between the bearing and the shaft is h7. Looser fit allowing lower speed is recommended when heavier load is applied.

3. Tolerances for Mounted Units

Table 3.1.1 Tolerances on inner rings of bearing with cylindrical bore

Unit: 0.001 mm

Nominal bore diameter <i>d</i>		Cylindrical bore						Radial run-out (Max.)
		Bore diameter <i>d_m</i>				Width <i>B_i</i>		
Over (mm)	Incl. (mm)	Deviations		Deviations		Deviations		
		High	Low	High	Low	High	Low	
10	18	+18	0	+22	-4	0	-120	12
18	30	+21	0	+25	-4	0	-120	15
30	50	+25	0	+30	-5	0	-120	18
50	80	+30	0	+36	-6	0	-150	22
80	120	+35	0	+42	-7	0	-200	28
120	150	+40	0	+48	-8	0	-250	35

Note: *d_m* is defined as the arithmetical mean of the largest and the smallest diameter obtained by two-point measurements.

Table 3.1.2 Tolerances on inner rings of bearings with tapered bore

Unit: 0.001 mm

Nominal bore diameter <i>d</i>		Δd		$\Delta d_1 - \Delta d$	
		High	Low	Max.	Min.
Over (mm)	Incl. (mm)				
18	30	+33	0	+21	0
30	50	+39	0	+25	0
50	80	+46	0	+30	0
80	120	+54	0	+35	0
120	150	+63	0	+40	0

Note (1) The deviations from nominal taper are defined by the limits of $(\Delta d_1 - \Delta d)$, where (Δd_1) is actual deviation of d_1 from nominal diameter at the largest end of bore and Δd is actual deviation of d from bearing bore nominal diameter.

(2) d_1 is obtained by the following formula:

$$d_1 = d + 0.083333 B$$

Where B is width of the bearing inner ring.

(3) The nominal taper angle = 2° 23'9.4"

(4) Please refer to the Figs. 3.1.2

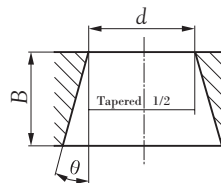
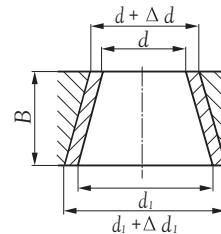

Figs. 3.1.2



Table 3.1.3 Tolerances on outer ring

Unit: 0.001 mm

Nominal bore diameter <i>D</i>		<i>D_m</i> Deviations		Radial run-out (Max.)
Over (mm)	Incl. (mm)	High	Low	
40	50	0	-11	20
50	80	0	-13	25
80	120	0	-15	35
120	180	0	-18	40
180	250	0	-20	45

Note: (1) *D_m* is defined as the arithmetical means of the largest and the smallest diameter obtained by two-point measurement.

(2) The low deviation of outside diameter *D_m* does not apply within the distance of 1/4 the width of outer ring from the sides.

Table 3.1.4 Tolerance for distance "n" between the radial plane passing through center of outer ring and aside of inner ring

Unit: 0.001 mm

Nominal bore diameter <i>d</i>		<i>n</i> Deviations
Over (mm)	Incl. (mm)	
40	50	±200
50	80	±250
80	120	±300
120	160	±350

Please refer to Fig. 3.1.4

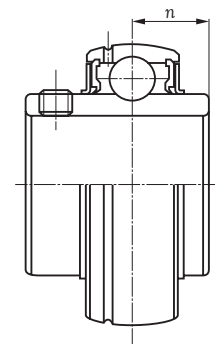

Fig. 3.1.4

Table 3.1.5 Chamfer dimensions

Nominal dimensions <i>r</i> (mm)	<i>r</i>	
	Max. (mm)	Min. (mm)
1.0	1.5	0.6
1.5	2.0	1.0
2.0	2.5	1.5
2.5	3.0	2.0
3.0	3.5	2.5
3.5	4.0	3.0
4.0	4.5	3.5
5.0	6.0	4.0

Please refer to Fig. 3.1.5

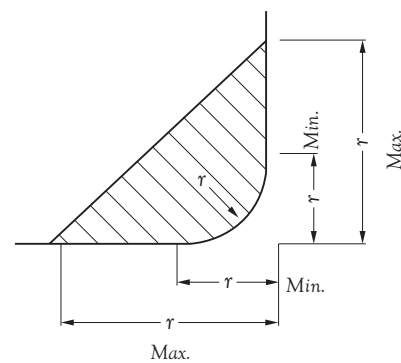

Fig. 3.1.5

3.2.1 Center height tolerances for pillow block type housings

Please refer to below Figs. 3.2.1 and Table 3.2.1

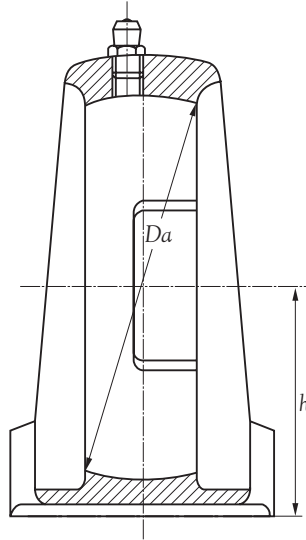

Fig. 3.2.1

Table 3.2.1 Center height tolerances for pillow block type housings

Unit: 0.001 mm

Housing No.				h Deviations
P 201		PA 201	PH 201	± 150
P 202	AK 204	PA 202	PH 202	
P 203	AK 205	PA 203	PH 203	
P 204	AK 206	PA 204	PH 204	
P 205	AK 207	PA 205	PH 205	
P 206	AK 208	PA 206	PH 206	
P 207	AK 209	PA 207	PH 207	
P 208	AK 210	PA 208	PH 208	
P 209	AK 211	PA 209	PH 209	
P 210	AK 212	PA 210	PH 210	
P 211	AK 213	PA 211	PH 211	± 200
P 212	AK 214	PA 212	PH 212	
P 213	AK 215	PA 213	PH 213	
P 214				
P 215				
P 216				
P 217				
P 218				



3.2.2 Tolerances for flanged type housings (F, FL, FA, FB, FC)

Please refer to below Figs. 3.2.2 (a), 3.2.2 (b) and Table 3.2.2 (a), 3.2.2 (b).

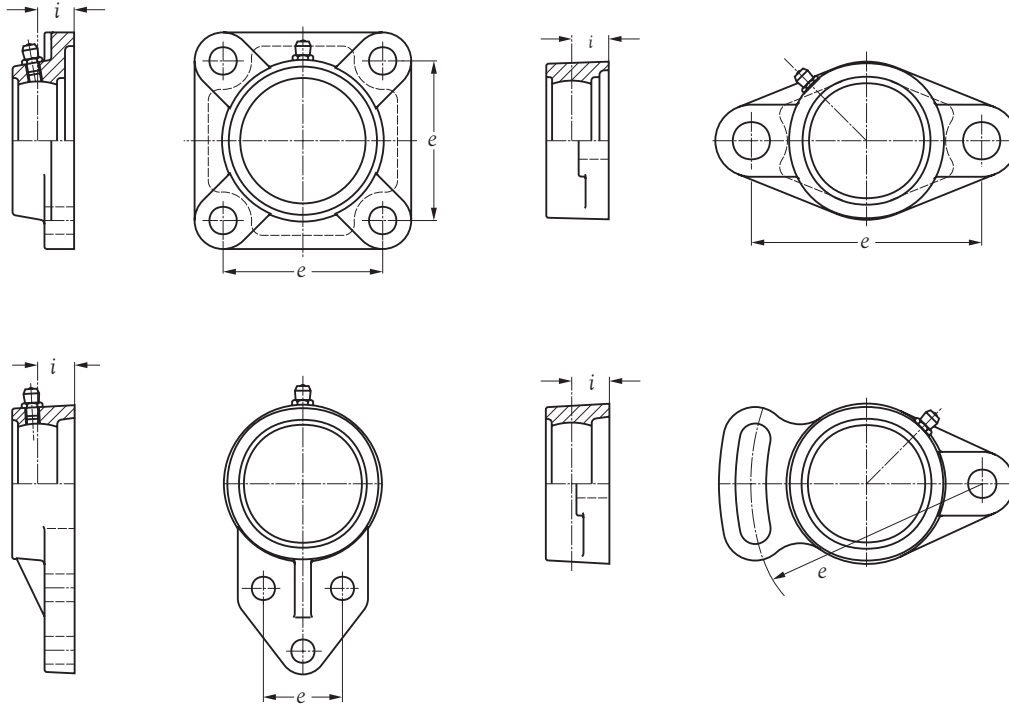

Figs. 3.2.2 (a)

Table 3.2.2 (a) Tolerances for flanged type housings (F, FL, FA, FB)

Unit: 0.001 mm

Housing No.				<i>e</i> Deviations	<i>i</i> Deviations
F 201	FL 201	FA 201	FB 201	± 700	± 500
F 202	FL 202	FA 202	FB 202		
F 203	FL 203	FA 203	FB 203		
F 204	FL 204	FA 204	FB 204		
F 205	FL 205	FA 205	FB 205		
F 206	FL 206	FA 206	FB 206		
F 207	FL 207	FA 207	FB 207		
F 208	FL 208	FA 208	FB 208		
F 209	FL 209	FA 209	FB 209		
F 210	FL 210	FA 210	FB 210		
F 211	FL 211	FA 211	FB 211	± 1000	± 800
F 212	FL 212	FA 212	FB 212		
F 213	FL 213	FA 213	FB 213		
F 214	FL 214				
F 215	FL 215				
F 216	FL 216				
F 217	FL 217				
F 218	FL 218				

Table 3.2.2 (b) Tolerance for flanged type housing (FC)

Unit: 0.001 mm

Housing No.	<i>f</i> Deviations		<i>e</i> Deviations	<i>i</i> Deviations	Radial run-out of machined pilot Max.
	High	Low			
FC 201	0	-46	± 700	± 700	200
FC 202					
FC 203					
FC 204					
FC 205					
FC 206					
FC 207	0	-54	± 1000	± 800	300
FC 208					
FC 209					
FC 210					
FC 211	0	-63	± 1000	± 800	300
FC 212					
FC 213					
FC 214					
FC 215					
FC 216					
FC 217	0	-72	± 1000	± 800	300
FC 218					

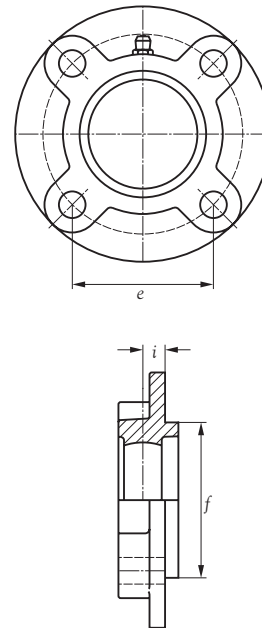

Figs. 3.2.2 (b)

3.2.3 Tolerance for take-up type housing (T)

Please refer to below Fig. 3.2.3 and Table 3.2.3 .

Table 3.2.3 Tolerance for take-up type housing (T)

Unit: 0.001 mm

Housing No.	<i>k</i> Deviations		<i>e</i> Deviations	Parallelism of guide Max.
	High	Low		
T 201 ~ T 210	+200	0	0, -500	500
T 211 ~ T 217	+300	0	0, -800	600

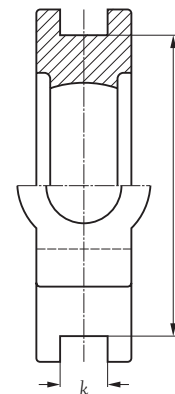

Fig. 3.2.3



Table 3.2.4 Tolerance on spherical inside diameter Unit: 0.001 mm

Nominal spherical inside diameter <i>Da</i>		Symbol J7			
Over (mm)	Incl. (mm)	<i>D_{am}</i> Deviations		<i>Da</i> Deviations	
		High	Low	High	Low
30	50	+14	-11	+19	-16
50	80	+18	-12	+24	-18
80	120	+22	-13	+29	-20
120	180	+26	-14	+34	-22
180	250	+30	-16	+39	-25

Note: (1) $D_{am} = (D_{a \max} + D_{a \min})/2$

D_{a max} - maximum measured value of *Da*

D_{a min} - minimum measured value of *Da*

(2) Dimensional tolerances for spherical inside diameter of housing are classified as J7 for interference fit.

Table 3.2.5 Machining tolerances

Nominal dimension		Dimensional Tolerance (mm)
Over (mm)	Incl. (mm)	
4	16	±0.2
16	63	±0.3
63	250	±0.5

Table 3.2.6 Casting tolerances on length

Nominal dimension		Dimensional Tolerance (mm)
Over (mm)	Incl. (mm)	
U _p	100	±1.5
100	200	±2.0
200	400	±3.0
400	800	±4.0

Table 3.2.7 Casting tolerances on thickness

Nominal dimension		Dimensional Tolerance (mm)
Over (mm)	Incl. (mm)	
U _p	5	±1.0
5	10	±1.5
10	20	±2.0
20	30	±3.0
30	50	±3.5

Table 3.2.8 One side machining tolerances

Nominal dimension			Dimensional Tolerance (mm)
Over (mm)		Incl. (mm)	
U _p	~	5	±1.0
5	~	100	±1.5
100	~	200	±2.0
200	~	400	±3.0

Note: (1) Dimensional tolerances and deviations are for ordinary grade.

(2) Dimensional tolerances on length and thickness may be added with deviations on draft taper.



4. Radial Internal Clearance of Bearings

The internal radial clearance for the Insert Ball Bearing is usually greater than that for the same size of Deep Groove Ball Bearing. The clearance for the cylindrical bore bearing is shown in Table 4.1 while the clearance for the tapered bore bearing is shown in Table 4.2 .

**Table 4.1 Radial internal clearance of cylindrical bore bearings
(with set-screws and eccentric locking collar)**

Unit: 0.001mm

Nominal bore diameter <i>d</i>		Clearance symbol					
Over (mm)	Incl. (mm)	C 2		Normal		C 3	
		Min.	Max.	Min.	Max.	Min.	Max.
10	18	0	9	3	18	11	25
18	24	0	10	5	20	13	28
24	30	1	11	5	20	13	28
30	40	1	11	6	20	15	33
40	50	1	11	6	23	18	36
50	65	1	15	8	28	23	43
65	80	1	15	10	30	25	51
80	100	1	18	12	36	30	58
100	120	2	20	15	41	36	66
120	140	2	23	18	48	41	81

Table 4.2 Radial internal clearance of tapered bore bearings (with adapter sleeve)

Unit: 0.001mm

Nominal bore diameter <i>d</i>		Clearance symbol					
Over (mm)	Incl. (mm)	C 2		Normal		C 3	
		Min.	Max.	Min.	Max.	Min.	Max.
24	30	5	20	13	28	23	41
30	40	6	20	15	33	28	46
40	50	6	23	18	36	30	51
50	65	8	28	23	43	38	61
65	80	10	30	25	51	46	71
80	100	12	36	30	58	53	84
100	120	15	41	36	66	61	97
120	140	18	48	41	81	71	114



5. Selection of Bearing Size

5.1 The bearing size is usually selected according to the required life and reliability under a specific type of load charged on the Insert Ball Bearing

The load applied to the bearing operating under static or slow oscillating and rotating ($n < 10 \text{ r/min}$) condition is defined as static load, while the load applied to the bearing operating under a speedy rotating ($n > 10 \text{ r/min}$) condition is defined as dynamic load.

The load capacity of the bearing is expressed by the basic dynamic load rating which is shown in the Insert Ball Bearing's table.

Under normal mounting, lubricating and maintaining conditions, the operating bearing will have fatigue flaking due to the repeating action of variable load charged on the contact area between the rings and rolling elements. Generally, the fatigue flaking is the cause of normal damage of rolling bearings. Therefore, the usual bearing life refers to the bearing fatigue life. The life of group of apparently identical bearings operating under a considerable dispersion. For this reason, the bearing life is closely connected with the damaging probability or the reliability requirement.

The radial rating load of ball bearing with 90% reliability and 500 hours minimum life is shown in Fig. 5.1 (Refer to page 18).

Life: The life of a rolling bearing is defined as the total number of revolution which the bearing is capable of enduring before the first evidence of fatigue flaking develops on any one rings or rolling elements.

Reliability: The reliability is the percentage of the bearings of a group of apparently identical bearings operating under identical conditions which can expect to attain or exceed a certain defined life. The reliability of individual bearing is the probability of the bearing to attain or exceed a defined life.

Basic rating life: For a group of apparently identical rolling bearings operating under identical conditions, the basic rating life is defined as the total number of revolution that 90% of the bearings can be expected to complete or exceed.

Basic Rating life

The fatigue rating life of Insert Ball Bearing is calculated by the following formula:

$$L_{10} = \left(\frac{C}{P}\right)^3 \text{ or } \frac{C}{P} = L_{10}^{1/3}$$

Where L_{10} = basic rating life (10^6 r)

P = basic dynamic load rating (N)

N = equivalent dynamic bearing load (N)

The basic dynamic load rating C is a hypothetical constant load with a fixed direction under which the bearing can attain a basic life of one million revolutions theoretically. For radial bearings, the load refers to the radial load.

The equivalent dynamic bearing load P is a constant load with a fixed direction under which the bearing life is identical to that of the bearing operating under actual load.

For a bearing operating with a constant rotation speed, the basic rating life can be expressed in terms of operating hours:

$$L_{10h} = \frac{10^6}{60n} \left(\frac{C}{P} \right)^3 \text{ or } L_{10h} = \frac{10^6}{60n} L_{10h} = \frac{16666}{n} \left(\frac{C}{P} \right)^3$$

Where L_{10h} = basic rating life (h)
 n = bearing operating speed of rotation (r/min)

For easier calculation, 500 hours as base of rating life is taken, and the speed factor f_n and the life factor f_h is introduced.

$$f_n = \left(\frac{331/3}{n} \right)^{1/3} \quad f_h = \left(\frac{L_{10h}}{500} \right)^{1/3}$$

In this way, the formula is simplified to: $C = \frac{f_h}{f_n} P$

The values of f_h and f_n can be found in Fig. 5.1 by referring to the operation speed n and the anticipated bearing service life L_{10h} . Then, with the radial load (or the equivalent dynamic bearing load), the basic dynamic load rating can be determined. By this way, the bearing size can be determined according to the basic dynamic load rating value in the Insert Ball Bearing's table. If the bearing operate under indeterminate loads and rotation speed, the following formula should be applied when calculating the bearing life:

$$P_m = \sqrt[3]{\frac{1}{N} \int_0^N P^3 dN}$$

Where P_m = mean equivalent dynamic bearing load (N)
 P = equivalent dynamic bearing load (N)
 N = total revolution numbers within one load changing cycle (r)

5.2 Anticipated bearing service life

Where selecting a bearing, one should usually predetermine an appropriate service life according to the relevant machine type, operating condition and reliability requirement. Generally the anticipated bearing service life can be determined by referring to the maintenance period of a machine.

Calculating method of equivalent dynamic bearing load P

The basic equivalent dynamic bearing load is determined under a hypothetical condition. When calculating the bearing life, the actual load has to be converted to dynamic bearing load which is in conformity with the load condition determining the dynamic load rating. General equation for calculating the equivalent dynamic bearing load:

$$P = \chi Fr + Yfa$$

Where: P --- equivalent dynamic bearing load (N)
 Fr --- actual radial load (N)
 Fa --- actual axial load (N)
 χ --- radial factor
 Y --- thrust factor

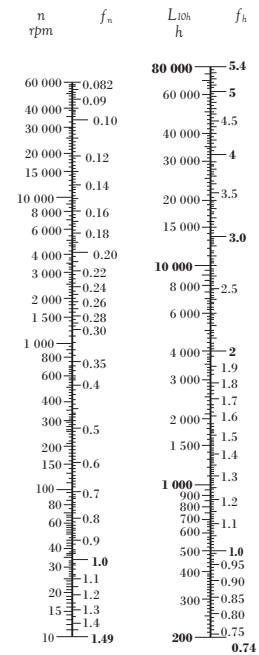

Fig. 5.1



The values of X and Y are determined by the ratio between the applied axial load F_a and the basic static load rating C_0 . The axial load which the Insert Ball Bearing can carry is determined by the mounting method of the bearing on the shaft.

For bearings of set-screw Locking type or eccentric Locking collar type, if flexible shafts are applied and the set-screws are tightened enough, the axial load F_a which the bearings can carry not surpass 20% of the radial load F_r .

For bearing of adapter sleeve Locking type, if the nut is properly tightened, the axial load F_a can be maximally 15% to 20% of the radial load.

The value of radial and thrust factors X and Y for Insert Ball Bearings can be obtained from the following Table 5.3.1.

When twist load is applied to the bearing, the equivalent dynamic bearing load is calculated by the following equation:

Where: $P_m = f_m \cdot P$
 P_m --- equivalent dynamic bearing load when considering twist load
 f_m --- twist load factor, which is defined as follows:
 when the twist load is small : $f_m = 1.5$
 when the twist load is big : $f_m = 2$

5.3 Example of bearing size selection

When shocking load is applied to the bearing, the equivalent dynamic bearing load can be calculated by the following equation:

$$P_d = f_d \cdot P$$

Where: P_d --- equivalent dynamic bearing load when considering shocking load
 f_d --- shocking load factor, which is defined as follows:
 when no shocking load or mirror shocking load is applied: $f_d = 1 - 1.2$
 when adequate shocking load is applied: $f_d = 1.2 - 1.8$

Table 5.3.1 Radial and thrust factors X and Y for Insert Ball Bearings

$\frac{F_a}{C_a}$	Clearance for normal				e	Clearance for C3				e
	$\frac{F_a}{F_r} \leq e$		$\frac{F_a}{F_r} > e$			$\frac{F_a}{F_r} \leq e$		$\frac{F_a}{F_r} > e$		
	X	Y	X	Y		X	Y	X	Y	
0.025	1	0	0.56	2.0	0.22	1	0	0.46	1.74	0.3
0.04	1	0	0.56	1.8	0.24	1	0	0.46	1.61	0.33
0.07	1	0	0.56	1.6	0.27	1	0	0.46	1.46	0.36
0.13	1	0	0.56	1.4	0.31	1	0	0.46	1.30	0.41
0.25	1	0	0.56	1.2	0.37	1	0	0.46	1.14	0.47
0.5	1	0	0.56	1.0	0.44	1	0	0.46	1.00	0.54

How to select the size of bearing

One Insert Ball Bearings is to operate at a rotation speed of 1000 r/min under only a radial load of $F_r = 3000\text{ N}$, with a basic rating life of at least 20,000 hours. Select the bearing size.

From the required rotation speed it can be found that:

$$f_n = 0.322 \text{ (Fig. 5.1 shows about 0.32)}$$

From the required basic rating life (anticipated service life), it can be found that:

$$f_h = 3.42 \text{ (Fig. 5.1 shows about 3.4)}$$

Under only radial load, i.e.

$$P = F_r = 3000\text{ N}$$

Therefore,

$$C = \frac{F_h}{f_n} P = \frac{3.42}{0.322} \times 3000 = 31,863\text{ (N)}$$

A simplified way to calculate the bearing life can be applied by using Fig. 5.3: By connecting n and the required basic rating life L_{10h} with a straight line, it can be found that C/P value is 10.6. As is known, $P = F_r = 3000\text{ N}$, thus the required basic dynamic load rating is:

$$C = 3000 \times 10.6 = 31,800\text{ (N)}$$

In this way, we can select the Insert Ball Bearings inside this catalogue.

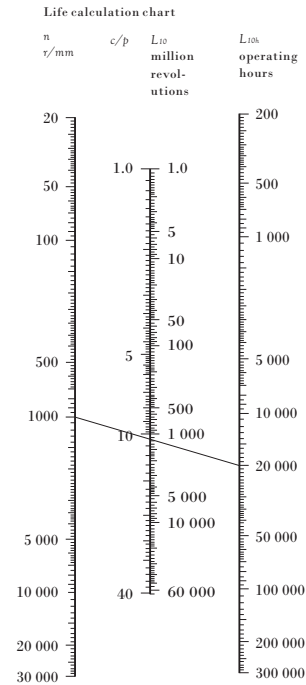

Fig. 5.3

5.4 Adjusted rating life equation

The basic rating life L_{10} calculated with the bearing life calculation formula can be applied to calculate the rating life of bearing made of ordinary bearing steel (i.e. bearing life with reliability of 90%).

Due to more and more of machinery products demanding higher reliability and better quality steel (ISO 281/1-1977), an adjusted rating life calculation equation is suggested, i. e.

$$L_n = a_1 \cdot a_2 \cdot a_3 \cdot L_{10}$$

For Spherical Outside Surface Ball Bearing:

$$L_n = a_1 \cdot a_2 \cdot a_3 \cdot (C/P)^3$$

Where L_n ---under specified material and lubricating conditions, bearing life with (100-n)% no breaking probability (i. e. reliability).

a_1 ---- life adjustment factor for reliability (Table 4.4.1)

a_2 ---- life adjustment factor materials (Table 4.4.2)

a_3 ---- life adjustment factor for operating conditions (Table 4.4.3)

Table 5.4.1 Life adjustment factor for reliability a_1

Reliability%	90	95	96	97	98	99
L_n	L_{10}	L_5	L_4	L_3	L_2	L_1
a_1	1	0.62	0.53	0.44	0.33	0.21



Table 5.4.2 Life adjustment factor for materials a_2

Normal chromium bearing steel		$a_2 = 1$
Special smelted bearing steel	-- Vacuum degassed bearing steel	$a_2 = 3$
	-- Vacuum resmelted bearing steel	$a_2 = 5$
When material hardness lowered by high frequency tempering		$a_2 < 1$

Table 5.4.3 Life adjustment factor for operating conditions a_3

When under normal operating conditions:		
(1) Properly mounted,		
(2) Sufficiently lubricated,		$a_3 = 1$
(3) Without outside matters intrusion.		
When under operating temperature, the Insert Ball Bearings lubricating		
grease viscosity lower than 13 mm ² /s		$a_3 < 1$

6. Selection of Shafts

The shaft on which bearing units are mounted shall be free from bend and flexure.

For the units with cylindrical bore (with set-screws or eccentric locking collar) clearance fit is usually adopted for mounting the units on the shaft, and shaft tolerances in Table 6.1 are recommended for such loose fit, but for high speed or highly accurate operation or such application which is accompanied by heavy shock loads, interference fit is to be adopted. Table 6.2 shows recommended shaft tolerances for interference fit, when mounted units with eccentric locking collar are mounted on the shaft with interference fit, the eccentric locking collar may be omitted.

Tapered bore bearings permit wider tolerances of the shaft since they are locked to the shaft by means of adapted sleeves.

Recommended shaft tolerances for tapered bore bearings listed in Table 6.3.

Table 6.1 Shaft tolerances for clearance fit for bearing with cylindrical bore

Shaft diameter		Deviation of tolerances in shaft							
		For lower speed h9		For medium speed h8		For rather high speed h7		For high speed j6	
		Max.	Min.	Max.	Min.	Max.	Min.	Max.	Min.
Over mm	Incl. mm								
10	18	0	-43	0	-27	0	-18	+8	-3
18	30	0	-52	0	-33	0	-21	+9	-4
30	50	0	-62	0	-39	0	-25	+11	-5
50	80	0	-74	0	-46	0	-30	+12	-7
80	120	0	-87	0	-54	0	-35	+13	-9
120	180	0	-100	0	-63	0	-40	+14	-11



Table 6.2 Shaft tolerance for interference fit for bearing with cylindrical bore

Shaft diameter		Deviation of tolerances in shaft							
		Higher speed		Rather heavy load		Highest load		Heavy load	
		Over mm	Incl. mm	m6		m7		m6	
		Max.	Min.	Max.	Min.	Max.	Min.	Max.	Min.
10	18	+18	+7	+25	+7	+23	+12	+30	+12
18	30	+21	+8	+29	+8	+28	+15	+36	+15
30	50	+25	+9	+34	+9	+33	+17	+42	+17
50	80	+30	+11	+41	+11	+39	+20	+50	+20
80	120	+35	+13	+48	+13	+45	+23	+58	+23
120	180	+40	+15	+55	+15	+52	+27	+67	+27

Table 6.3 Shaft tolerances for bearing with tapered bore

Shaft diameter		Deviation of tolerances in shaft			
		For shot shaft		For shot shaft	
		Over mm	Incl. mm	h9	h10
		Max.	Min.	Max.	Min.
10	18	0	-43	0	-70
18	30	0	-52	0	-84
30	50	0	-62	0	-100
50	80	0	-74	0	-120
80	120	0	-87	0	-140
120	180	0	-100	0	-160

7. Mounting of Mounted Units on Shafts

The mounted units can be easily installed in principle at any place. However, in order to have a long service life, it is desirable that the mounting base is flat and rigid.

In case of either the vibration is caused to the bearing, the alternating movement takes place, the load applied to the bearing is large, or the shaft rotation speed is rapid, it is desired to provide with the filed seat or concave section at the part where the set-screws contact with the shaft. If large thrust load is charged, it is recommended that joggling tightened with nuts be used to install the bearing most effectively to the shaft: As shown in Fig 7.1.

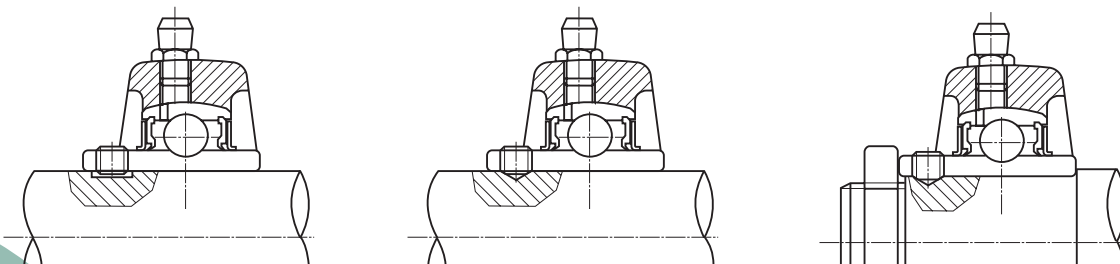

Fig 7.1



7.1 Mounted units with adapter sleeve

Mounted unit with adapter sleeve permits wider shaft tolerance and can be used in applications where vibrations and shocks are heavy.

Mounting processes of these units are as follows:

First, the sleeve is installed to an arbitrary position. After the shark proof washer is inserted, the nut is tightened. The proper nut tightening condition can be obtained if it is tightened enough by hand and then rotated by 2/5 to 3/5 revolution with a spanner.

After tightening the nut, bend the shark proof washer within the slot. Otherwise, the nut may be loosened and creep may be caused between the shaft and sleeve. It is necessary the nut can not be tightened too much.

7.2 Mounted units with eccentric locking collar

The eccentric part of the collar mates with the inner ring of the bearing which is made eccentric with the collar. When locked to the shaft by hand in direction of the shaft rotation, the eccentric locking collar tightens automatically to the shaft by force of working radial load. Then, lock the set-screws provided on the collar to fix the eccentric collar to the shaft. At the shaft rotation force or load is not charged on the set-screws directly, it will not loosen during operation.

8. Standard of Set-screws

There are two set-screws located at two places on one side of the wide inner ring 120 apart with which the bearing units can be mounted to the shaft. When mounting the bearing to the shaft, the torque shown in the following Table 8.1 is recommended to tighten the set-screws to shaft.

Table 8.1 Proper tightening torque of set-screws

Set-screws tap (mm) (inch)		Model Nos. of insert ball bearings	Tightening torque (N.m) (lbf.in)	
M5 x 0.8	10#-32 UNF	UC 201~UC 203, SB 201~SB 203, CSB 201~CSB 203 CSB 201-8~CSB 203-11	3.0~3.5	28
M6 x 0.75		UC 204~UC 206, SB 204~SB 206	3.0~3.5	28
M6 x 1	1/4-28 UNF	SA 201~SA 206, CSA 201~CSA 206, CSB 204~CSB 207 SER 201~SER 206 CSB 204-12~CSB 207-22, SER 201-10~SER 206-20	3.5~4.0	30~35.4
M8 x 1	5/16-24 UNF	UC 207~UC 209, SA 207~SA 210, SB 207~SB 208 CSA 207~CSA 210, CSB 208, SER 207~SER 209 CSB 208-24, SER 207-22~SER 209-28	8.0~8.5	69~73.5
M10 x 1.25	3/8-24 UNF	UC 210~UC 213, SA 211, CSA 211~CSA 212, SER 210~SER 212 SER 210-30~SER 212-36	16.5~17.5	144~152
M12 x 1.25	7/16-20 UNF	SER 214~SER 215 SER 214-40~SER 215-47	26.5~27.5	235~243
M12 x 1.5		UC 214~UC 218	33.5~34.5	296~304

9. Material for Cast Iron Housing

The material of cast iron housing under ISO / DIS GG20, the mechanical properties please refer to Tabel 9.1.

Table 9.1 The mechanical properties of cast iron housing

Number	Major wall thickness of casting piece (mm)	Strain stress σ_b (N/mm^2)	Hardness HB
JIS FC20	2.5 - 10	220	170 - 220
	>10 - 20	195	
	>20 - 30	170	
	>30 - 50	160	





KSM[®]



Product Information



Standard Duty Pillow Blocks Cast Housing Set Screws Type series UCAK 200

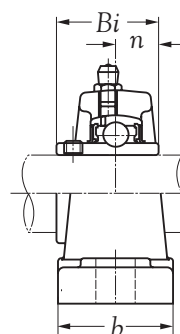
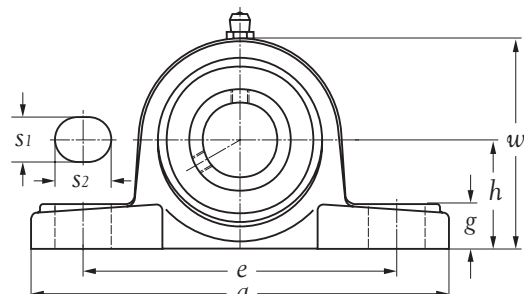

Shaft dia. mm inch	Unit number	Nominal dimensions										Bolt size mm inch	Bearing number	Housing number	Mass of unit kg
		mm inch													
		<i>h</i>	<i>a</i>	<i>e</i>	<i>b</i>	<i>s</i> ₁	<i>s</i> ₂	<i>g</i>	<i>w</i>	<i>Bi</i>	<i>n</i>				
20 3/4	UCAK 204	31.8	128	98	38	11.0	14	14	63.0	31.0	12.7	M 10	UC 204	AK 204	0.74
	UCAK 204-12	1-1/4	5-1/16	3-55/64	1-1/2	7/16	35/64	35/64	2-31/64	1.2205	0.5000	3/8	UC 204-12		0.75
25 1	UCAK 205	33.3	140	105	40	11.0	14	15	66.5	34.0	14.3	M 10	UC 205	AK 205	0.85
	UCAK 205-16	1-5/16	5-3/64	4-9/64	1-37/64	7/16	35/64	19/32	2-5/8	1.3386	0.5630	3/8	UC 205-16		0.84
30 1-1/8 1-1/4	UCAK 206	39.7	160	121	44	14.0	19	17	79.0	38.1	15.9	M 12	UC 206		1.24
	UCAK 206-18	1-9/16	6-19/64	4-49/64	1-47/64	35/64	3/4	43/64	3-7/64	1.5000	0.6260	7/16	UC 206-18	AK 206	1.26
	UCAK 206-20												UC 206-20		1.22
35 1-1/4 1-3/8	UCAK 207	46.0	167	127	48	14.0	19	18	91.0	42.9	17.5	M 12	UC 207		1.70
	UCAK 207-20	1-13/16	6-37/64	5	1-57/64	35/64	3/4	45/64	3-37/64	1.6890	0.6890	7/16	UC 207-20	AK 207	1.76
	UCAK 207-22												UC 207-22		1.71
40 1-1/2	UCAK 208	49.2	181	140	52	14.0	19	19	98.0	49.2	19.0	M 12	UC 208		2.13
	UCAK 208-24	1-15/16	7-1/8	5-3/64	2-1/16	35/64	3/4	3/4	3-55/64	1.9370	0.7480	7/16	UC 208-24	AK 208	2.17
45 1-5/8	UCAK 209	52.4	189	146	54	14.0	19	20	105.0	49.2	19.0	M 12	UC 209		2.39
	UCAK 209-26	2-1/16	7-7/16	5-3/4	2-1/8	35/64	3/4	25/32	4-9/64	1.9370	0.7480	7/16	UC 209-26	AK 209	2.49
50 1-7/8	UCAK 210	55.6	203	159	57	17.5	21	21	111.5	51.6	19.0	M 16	UC 210		2.83
	UCAK 210-30	2-3/16	7-63/64	6-17/64	2-1/4	11/16	53/64	53/64	4-25/64	2.0315	0.7480	5/8	UC 210-30	AK 210	2.90
55 2	UCAK 211	61.9	232	181	60	18.0	24	23	123.0	55.6	22.2	M 16	UC 211		3.85
	UCAK 211-32	2-7/16	9-9/64	7-1/8	2-23/64	45/64	15/16	29/32	4-27/32	2.1890	0.8740	5/8	UC 211-32	AK 211	4.00
60 2-1/4	UCAK 212	68.3	241	191	64	18.0	24	25	136.0	65.1	25.4	M 16	UC 212		4.92
	UCAK 212-36	2-11/16	9-31/64	7-3/64	2-3/64	45/64	15/16	63/64	5-23/64	2.5630	1.0000	5/8	UC 212-36	AK 212	5.06
65 2-1/2	UCAK 213	74.6	262	203	70	21.0	28	27	147.5	65.1	25.4	M 20	UC 213		6.13
	UCAK 213-40	2-15/16	10-5/16	7-63/64	2-3/4	53/64	1-7/64	1-1/16	5-13/16	2.5630	1.0000	3/4	UC 213-40	AK 213	6.21
70 2-3/4	UCAK 214	77.8	266	210	74	21.0	28	28	153.5	74.6	30.2	M 20	UC 214		6.90
	UCAK 214-44	3-1/16	10-15/32	8-17/64	2-29/32	53/64	1-7/64	1-7/64	6-1/16	2.9370	1.1890	3/4	UC 214-44	AK 214	6.91
75 3	UCAK 215	82.6	304	241	78	22.0	32	30	162.0	77.8	33.3	M 20	UC 215		8.56
	UCAK 215-48	3-1/4	11-31/32	9-31/64	3-5/64	55/64	1-17/64	1-3/16	6-3/8	3.0630	1.3110	3/4	UC 215-48	AK 215	8.48

Standard Duty Pillow Blocks Cast Housing Set Screws Type series UCP 200

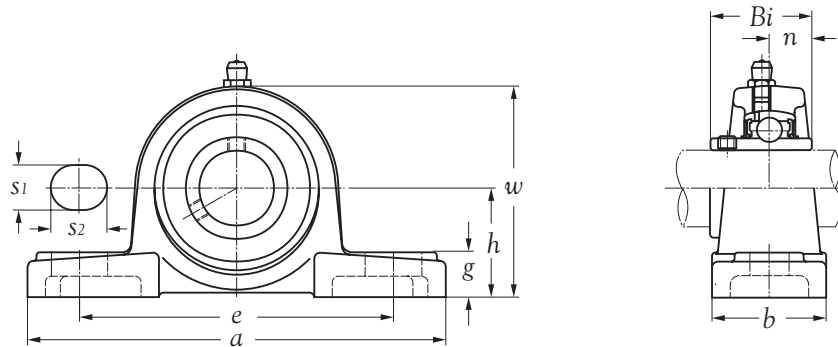

Shaft dia. mm inch	Unit number	Nominal dimensions										Bolt size mm inch	Bearing number	Housing number	Mass of unit kg
		mm inch													
		h	a	e	b	s ₁	s ₂	g	w	Bi	n				
12 1/2	UCP 201	30.2	127	96	38	13	16	11	60.7	31.0	12.7	M 10	UC 201	P 203	0.68
	UCP 201-8	1-3/16	5	3-25/32	1-1/2	3/64	5/8	7/16	2-25/64	1.2205	0.5000	3/8	UC 201-8		0.68
15 5/8	UCP 202	30.2	127	96	38	13	16	11	60.7	31.0	12.7	M 10	UC 202	P 203	0.67
	UCP 202-10	1-3/16	5	3-25/32	1-1/2	3/64	5/8	7/16	2-25/64	1.2205	0.5000	3/8	UC 202-10		0.67
17 11/16	UCP 203	30.2	127	96	38	13	16	11	60.7	31.0	12.7	M 10	UC 203	P 203	0.66
	UCP 203-11	1-3/16	5	3-25/32	1-1/2	3/64	5/8	7/16	2-25/64	1.2205	0.5000	3/8	UC 203-11		0.66
20 3/4	UCP 204	33.3	127	96	35	13	19	14	65.0	31.0	12.7	M 10	UC 204	P 204	0.66
	UCP 204-12	1-5/16	5	3-25/32	1-3/8	3/64	3/4	35/64	2-9/16	1.2205	0.5000	3/8	UC 204-12		0.67
25 1	UCP 205	36.5	140	105	36	13	19	15	71.0	34.0	14.3	M 10	UC 205	P 205	0.77
	UCP 205-16	1-7/16	5-3/64	4-9/64	1-27/64	3/64	3/4	19/32	2-51/64	1.3386	0.5630	3/8	UC 205-16		0.76
30 1-1/8 1-1/4	UCP 206	42.9	160	121	42	17	22	16	84.0	38.1	15.9	M 14	UC 206	P 206	1.22
	UCP 206-18	1-11/16	6-19/64	4-49/64	1-21/32	43/64	55/64	5/8	3-5/16	1.5000	0.6260	1/2	UC 206-18		1.24
	UCP 206-20												UC 206-20		1.20
35 1-1/4 1-3/8	UCP 207	47.6	167	127	45	17	22	17	94.0	42.9	17.5	M 14	UC 207	P 207	1.55
	UCP 207-20	1-7/8	6-37/64	5	1-49/64	43/64	55/64	43/64	3-45/64	1.6890	0.6890	1/2	UC 207-20		1.61
	UCP 207-22												UC 207-22		1.56
40 1-1/2	UCP 208	49.2	180	137	49	17	22	18	100.0	49.2	19.0	M 14	UC 208	P 208	1.88
	UCP 208-24	1-15/16	7-3/32	5-25/64	1-59/64	43/64	55/64	45/64	3-15/16	1.9370	0.7480	1/2	UC 208-24		1.92
45 1-5/8	UCP 209	54	189	146	50	17	22	20	107.5	49.2	19.0	M 14	UC 209	P 209	2.19
	UCP 209-26	2-1/8	7-7/16	5-3/4	1-31/32	43/64	55/64	25/32	4-15/64	1.9370	0.7480	1/2	UC 209-26		2.29
50 1-7/8	UCP 210	57.2	204	159	56	20	25	21	114.0	51.6	19.0	M 16	UC 210	P 210	2.73
	UCP 210-30	2-1/4	8-1/64	6-17/64	2-13/64	25/32	63/64	53/64	4-31/64	2.0315	0.7480	5/8	UC 210-30		2.80
55 2	UCP 211	63.5	217	172	58	20	25	22	126	55.6	22.2	M 16	UC 211	P 211	3.38
	UCP 211-32	2-1/2	8-35/64	6-49/64	2-9/32	25/32	63/64	55/64	4-61/64	2.1890	0.8740	5/8	UC 211-32		3.53
60 2-1/4	UCP 212	69.9	238	186	64	20	25	24	139	65.1	25.4	M 16	UC 212	P 212	4.75
	UCP 212-36	2-3/4	9-3/8	7-21/64	2-3/64	25/32	63/64	15/16	5-15/32	2.5630	1.0000	5/8	UC 212-36		4.89
65 2-1/2	UCP 213	76.2	262	203	70	25	30	26	149	65.1	25.4	M 20	UC 213	P 213	5.81
	UCP 213-40	3	10-5/16	7-63/64	2-3/4	63/64	1-3/16	1-1/64	5-55/64	2.5630	1.0000	3/4	UC 213-40		5.89
70 2-3/4	UCP 214	79.4	266	210	72	25	30	27	155	74.6	30.2	M 20	UC 214	P 214	6.50
	UCP 214-44	3-1/8	10-15/32	8-17/64	2-53/64	63/64	1-3/16	1-1/16	6-7/64	2.9370	1.1890	3/4	UC 214-44		6.51
75 3	UCP 215	82.6	274	217	74	25	30	28	161.6	77.8	33.3	M 20	UC 215	P 215	7.11
	UCP 215-48	3-1/4	10-25/32	8-35/64	2-29/32	63/64	1-3/16	1-7/64	6-23/64	3.0630	1.3110	3/4	UC 215-48		7.03

Standard Duty Pillow Blocks Cast Housing Set Screws Type series UCP 200

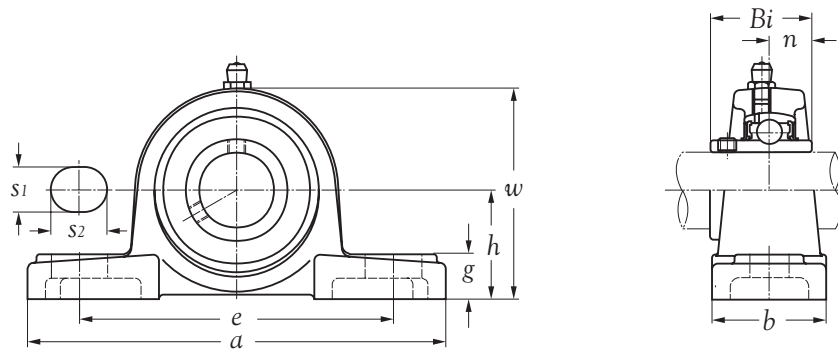

Shaft dia. mm inch	Unit number	Nominal dimensions										Bolt size mm inch	Bearing number	Housing number	Mass of unit kg
		<i>h</i>	<i>a</i>	<i>e</i>	<i>b</i>	<i>s</i> ₁	<i>s</i> ₂	<i>g</i>	<i>w</i>	<i>B</i> _i	<i>n</i>				
80 3-1/8	UCP 216	88.9	292	232	78	25	30	30	174	82.6	33.3	M 20	UC 216	P 216	8.69
	UCP 216-50	3-1/2	11-1/2	9-9/64	3-5/64	63/64	1-3/16	1-3/16	6-27/32	3.2520	1.3110	3/4	UC 216-50		8.74
85 3-1/4	UCP 217	95.2	310	247	83	25	30	32	186	85.7	34.1	M 20	UC 217	P 217	10.63
	UCP 217-52	3-3/4	12-13/64	9-23/32	3-17/64	63/64	1-3/16	1-17/64	7-21/64	3.3740	1.3425	3/4	UC 217-52		10.85
90 3-1/2	UCP 218	101.6	326	262	88	27	30	33	198	96.0	39.7	M 22	UC 218	P 218	12.95
	UCP 218-56	4	12-53/64	10-5/16	3-15/32	1-1/16	1-3/16	1-19/64	7-51/64	3.7800	1.5630	7/8	UC 218-56		13.06

Standard Duty Pillow Blocks Cast Housing Adapter Type series UKP 200

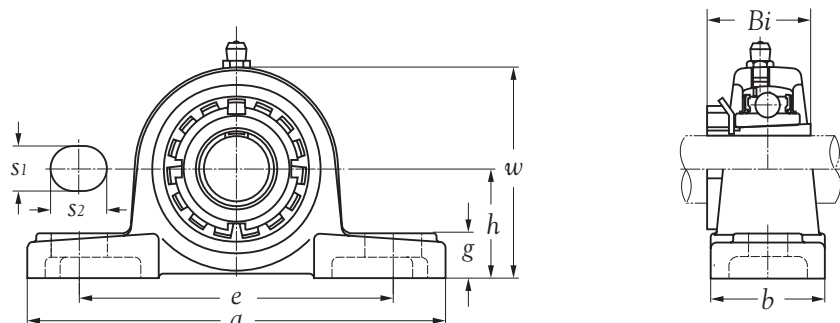

Shaft dia. mm	Unit number	Nominal dimensions									Bolt size mm	Bearing number	Housing number	Mass of unit kg
		<i>h</i>	<i>a</i>	<i>e</i>	<i>b</i>	<i>s</i> ₁	<i>s</i> ₂	<i>g</i>	<i>w</i>	<i>B</i> _i				
20	UKP 205	36.5	140	105	36	13	19	15	71.0	35	M 10	UK 205	P 205	0.71
25	UKP 206	42.9	160	121	42	17	22	16	84.0	38	M 12	UK 206	P 206	1.15
30	UKP 207	47.6	167	127	45	17	22	17	94.0	43	M 12	UK 207	P 207	1.45
35	UKP 208	49.2	180	137	49	17	22	18	100.0	46	M 12	UK 208	P 208	1.72
40	UKP 209	54.0	189	146	50	17	22	20	107.5	50	M 12	UK 209	P 209	2.04
45	UKP 210	57.2	204	159	56	20	25	21	114.0	55	M 16	UK 210	P 210	2.52
50	UKP 211	63.5	217	172	58	20	25	22	126.0	59	M 16	UK 211	P 211	3.03
55	UKP 212	69.9	238	186	64	20	25	24	139.0	62	M 16	UK 212	P 212	4.25
60	UKP 213	76.2	262	203	70	25	30	26	149.0	65	M 20	UK 213	P 213	5.31

Standard Duty Pillow Blocks Cast Housing Set Screws Type series UCPA 200

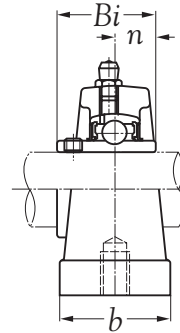
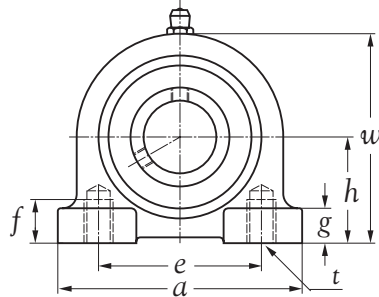

Shaft dia. mm inch	Unit number	Nominal dimensions										Bolt size mm inch	Bearing number	Housing number	Mass of unit kg
		h	a	e	b	g	w	f	t	Bi	n				
12 1/2	UCPA 201	30.2	76	52	40	11	62	13	M 10	31.0	12.7	M 10	UC 201	PA 204	0.57
	UCPA 201-8	1-3/16	2-63/64	2-1/16	1-37/64	7/16	2-7/16	3/64	3/8	1.2205	0.5000	3/8	UC 201-8		0.57
15 5/8	UCPA 202	30.2	76	52	40	11	62	13	M 10	31.0	12.7	M 10	UC 202	PA 204	0.56
	UCPA 202-10	1-3/16	2-63/64	2-1/16	1-37/64	7/16	2-7/16	3/64	3/8	1.2205	0.5000	3/8	UC 202-10		0.56
17 11/16	UCPA 203	30.2	76	52	40	11	62	13	M 10	31.0	12.7	M 10	UC 203	PA 204	0.55
	UCPA 203-11	1-3/16	2-63/64	2-1/16	1-37/64	7/16	2-7/16	3/64	3/8	1.2205	0.5000	3/8	UC 203-11		0.55
20 3/4	UCPA 204	30.2	76	52	40	11	62	13	M 10	31.0	12.7	M 10	UC 204	PA 204	0.53
	UCPA 204-12	1-3/16	2-63/64	2-1/16	1-37/64	7/16	2-7/16	3/64	3/8	1.2205	0.5000	3/8	UC 204-12		0.54
25 1	UCPA 205	36.5	84	56	38	12	72	15	M 10	34.0	14.3	M 10	UC 205	PA 205	0.71
	UCPA 205-16	1-7/16	3-5/16	2-13/64	1-1/2	15/32	2-53/64	19/32	3/8	1.3386	0.5630	3/8	UC 205-16		0.70
30 1-1/8 1-1/4	UCPA 206	42.9	94	66	48	13	84	18	M 14	38.1	15.9	M 14	UC 206	PA 206	1.07
	UCPA 206-18	1-11/16	3-45/64	2-19/32	1-57/64	3/64	3-5/16	45/64	1/2	1.5000	0.6260	1/2	UC 206-18		1.09
	UCPA 206-20	1-11/16	3-45/64	2-19/32	1-57/64	3/64	3-5/16	45/64	1/2	1.5000	0.6260	1/2	UC 206-20		1.05
35 1-1/4 1-3/8	UCPA 207	47.6	110	80	48	13	95	20	M 14	42.9	17.5	M 14	UC 207	PA 207	1.49
	UCPA 207-20	1-7/8	4-21/64	3-5/32	1-57/64	3/64	3-47/64	25/32	1/2	1.6890	0.6890	1/2	UC 207-20		1.55
	UCPA 207-22	1-7/8	4-21/64	3-5/32	1-57/64	3/64	3-47/64	25/32	1/2	1.6890	0.6890	1/2	UC 207-22		1.50
40 1-1/2	UCPA 208	49.2	116	84	54	13	100	20	M 14	49.2	19.0	M 14	UC 208	PA 208	1.75
	UCPA 208-24	1-15/16	4-9/16	3-5/16	2-1/8	3/64	3-15/16	25/32	1/2	1.9370	0.7480	1/2	UC 208-24		1.79
45 1-5/8	UCPA 209	54.2	120	90	60	13	108	25	M 14	49.2	19.0	M 14	UC 209	PA 209	2.17
	UCPA 209-26	2-9/64	4-23/32	3-35/64	2-23/64	3/64	4-1/4	63/64	1/2	1.9370	0.7480	1/2	UC 209-26		2.27
50 1-7/8	UCPA 210	57.2	130	94	60	14	116	25	M 16	51.6	19.0	M 16	UC 210	PA 210	2.53
	UCPA 210-30	2-1/4	5-1/8	3-45/64	2-23/64	35/64	4-9/16	63/64	5/8	2.0315	0.7480	5/8	UC 210-30		2.60
55 2	UCPA 211	63.5	140	104	66	14	125	25	M 16	55.6	22.2	M 16	UC 211	PA 211	3.17
	UCPA 211-32	2-1/2	5-3/64	4-3/32	2-19/32	35/64	4-59/64	63/64	5/8	2.1890	0.8740	5/8	UC 211-32		3.32
60 2-1/4	UCPA 212	69.9	150	114	68	15	138	25	M 16	65.1	25.4	M 16	UC 212	PA 212	4.17
	UCPA 212-36	2-3/4	5-29/32	4-31/64	2-43/64	19/32	5-7/16	63/64	5/8	2.5630	1.0000	5/8	UC 212-36		4.31
65 2-1/2	UCPA 213	76.2	160	124	70	15	150	25	M 16	65.1	25.4	M 16	UC 213	PA 213	4.96
	UCPA 213-40	3	6-19/64	4-7/8	2-3/4	19/32	5-29/32	63/64	5/8	2.5630	1.0000	5/8	UC 213-40		5.04

Standard Duty Pillow Blocks Cast Housing Adapter Type series UKPA 200

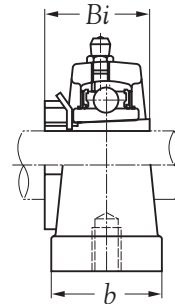
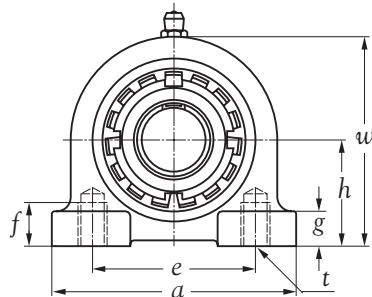

Shaft dia. mm	Unit number	Nominal dimensions									Bolt size mm	Bearing number	Housing number	Mass of unit kg
		<i>h</i>	<i>a</i>	<i>e</i>	<i>b</i>	mm <i>g</i>	<i>w</i>	<i>f</i>	<i>t</i>	<i>Bi</i>				
20	UKPA 205	36.5	84	56	38	12	72	15	M 10	35	M 10	UK 205	PA 205	0.65
25	UKPA 206	42.9	94	66	48	13	84	18	M 14	38	M 14	UK 206	PA 206	1.00
30	UKPA 207	47.6	110	80	48	13	95	20	M 14	43	M 14	UK 207	PA 207	1.39
35	UKPA 208	49.2	116	84	54	13	100	20	M 14	46	M 14	UK 208	PA 208	1.59
40	UKPA 209	54.2	120	90	60	13	108	25	M 14	50	M 14	UK 209	PA 209	2.02
45	UKPA 210	57.2	130	94	60	14	116	25	M 16	55	M 16	UK 210	PA 210	2.32
50	UKPA 211	63.5	140	104	66	14	125	25	M 16	59	M 16	UK 211	PA 211	2.82
55	UKPA 212	69.9	150	114	68	15	138	25	M 16	62	M 16	UK 212	PA 212	3.67
60	UKPA 213	76.2	160	124	70	15	150	25	M 16	65	M 16	UK 213	PA 213	4.46

Standard Duty Pillow Blocks Cast Housing Set Screws Type series UCPH 200

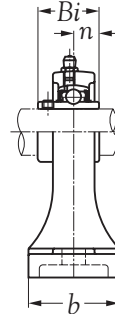
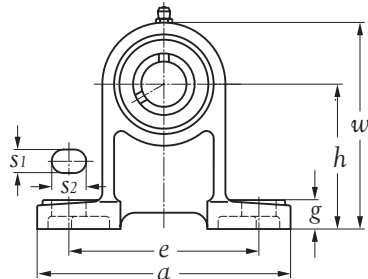

Shaft dia. mm inch	Unit number	Nominal dimensions										Bolt size mm inch	Bearing number	Housing number	Mass of unit kg
		mm inch													
		h	a	e	b	s ₁	s ₂	g	w	Bi	n				
12 1/2	UCPH 201	70	127	95	40	12	16	13	101	31.0	12.7	M 10	UC 201	PH 204	0.81
	UCPH 201-8	2-3/4	5	3-47/64	1-37/64	15/32	5/8	3/64	3-31/32	1.2205	0.5000	3/8	UC 201-8		0.81
15 5/8	UCPH 202	70	127	95	40	12	16	13	101	31.0	12.7	M 10	UC 202	PH 204	0.80
	UCPH 202-10	2-3/4	5	3-47/64	1-37/64	15/32	5/8	3/64	3-31/32	1.2205	0.5000	3/8	UC 202-10		0.80
17 11/16	UCPH 203	70	127	95	40	12	16	13	101	31.0	12.7	M 10	UC 203	PH 204	0.79
	UCPH 203-11	2-3/4	5	3-47/64	1-37/64	15/32	5/8	3/64	3-31/32	1.2205	0.5000	3/8	UC 203-11		0.79
20 3/4	UCPH 204	70	127	95	40	12	16	13	101	31.0	12.7	M 10	UC 204	PH 204	0.77
	UCPH 204-12	2-3/4	5	3-47/64	1-37/64	15/32	5/8	3/64	3-31/32	1.2205	0.5000	3/8	UC 204-12		0.78
25 1	UCPH 205	80	140	105	50	13	19	16	114	34.0	14.3	M 10	UC 205	PH 205	1.01
	UCPH 205-16	3-5/32	5-3/64	4-9/64	1-31/32	3/64	3/4	5/8	4-31/64	1.3386	0.5630	3/8	UC 205-16		1.00
30 1-1/8 1-1/4	UCPH 206	90	165	121	50	17	21	18	130	38.1	15.9	M 14	UC 206	PH 206	1.56
	UCPH 206-18	3-35/64	6-1/2	4-49/64	1-31/32	43/64	53/64	45/64	5-1/8	1.5000	0.6260	1/2	UC 206-18		1.58
	UCPH 206-20												UC 206-20		1.54
35 1-1/4 1-3/8	UCPH 207	95	167	127	60	17	21	19	140	42.9	17.5	M 14	UC 207	PH 207	1.88
	UCPH 207-20	3-47/64	6-37/64	5	2-23/64	43/64	53/64	3/4	5-3/64	1.6890	0.6890	1/2	UC 207-20		1.94
	UCPH 207-22												UC 207-22		1.89
40 1-1/2	UCPH 208	100	184	137	66	17	21	20	150	49.2	19.0	M 14	UC 208	PH 208	2.44
	UCPH 208-24	3-15/16	7-1/4	5-25/64	2-19/32	43/64	53/64	25/32	5-29/32	1.9370	0.7480	1/2	UC 208-24		2.48
45 1-5/8	UCPH 209	105	190	146	70	17	21	20	158	49.2	19.0	M 14	UC 209	PH 209	2.72
	UCPH 209-26	4-9/64	7-31/64	5-3/4	2-3/4	43/64	53/64	25/32	6-7/32	1.9370	0.7480	1/2	UC 209-26		2.82
50 1-7/8	UCPH 210	110	204	159	70	19	22	22	165	51.6	19.0	M 16	UC 210	PH 210	3.08
	UCPH 210-30	4-21/64	8-1/64	6-17/64	2-3/4	3/4	55/64	55/64	6-1/2	2.0315	0.7480	5/8	UC 210-30		3.15
55 2	UCPH 211	120	217	171	75	19	22	23	181	55.6	22.2	M 16	UC 211	PH 211	4.05
	UCPH 211-32	4-23/32	8-35/64	6-47/64	2-61/64	3/4	55/64	29/32	7-1/8	2.1890	0.8740	5/8	UC 211-32		4.20
60 2-1/4	UCPH 212	130	236	186	80	19	22	24	197	65.1	25.4	M 16	UC 212	PH 212	4.78
	UCPH 212-36	5-1/8	9-19/64	7-21/64	3-5/32	3/4	55/64	15/16	7-3/4	2.5630	1.0000	5/8	UC 212-36		4.92
65 2-1/2	UCPH 213	140	258	203	85	23	28	26	213	65.1	25.4	M 20	UC 213	PH 213	5.93
	UCPH 213-40	5-3/64	10-5/32	7-63/64	3-11/32	29/32	1-7/64	1-1/64	8-25/64	2.563	1.0000	3/4	UC 213-40		6.01

Standard Duty Two Bolts Flanged Units Cast Housing Set Screws Type series UCFL 200

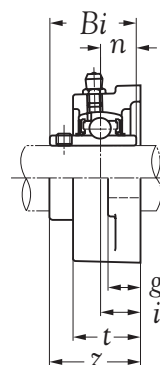
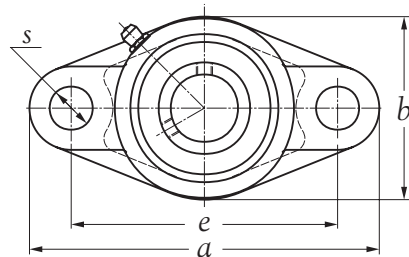

Shaft dia. mm inch	Unit number	Nominal dimensions										Bolt size mm inch	Bearing number	Housing number	Mass of unit kg
		a	e	i	g	t	s	b	z	Bi	n				
12 1/2	UCFL 201	113	90	15	11	25.5	12	60	33.3	31.0	12.7	M 10	UC 201	FL 204	0.47
	UCFL 201-8	4-29/64	3-35/64	19/32	7/16	1	15/32	2-23/64	1-5/16	1.2205	0.5000	3/8	UC 201-8	FL 204	0.47
15 5/8	UCFL 202	113	90	15	11	25.5	12	60	33.3	31.0	12.7	M 10	UC 202	FL 204	0.46
	UCFL 202-10	4-29/64	3-35/64	19/32	7/16	1	15/32	2-23/64	1-5/16	1.2205	0.5000	3/8	UC 202-10	FL 204	0.46
17 11/16	UCFL 203	113	90	15	11	25.5	12	60	33.3	31.0	12.7	M 10	UC 203	FL 204	0.45
	UCFL 203-11	4-29/64	3-35/64	19/32	7/16	1	15/32	2-23/64	1-5/16	1.2205	0.5000	3/8	UC 203-11	FL 204	0.45
20 3/4	UCFL 204	113	90	15	11	25.5	12	60	33.3	31.0	12.7	M 10	UC 204	FL 204	0.43
	UCFL 204-12	4-29/64	3-35/64	19/32	7/16	1	15/32	2-23/64	1-5/16	1.2205	0.5000	3/8	UC 204-12	FL 204	0.44
25 1	UCFL 205	130	99	16	13	27.0	16	68	35.7	34.0	14.3	M 14	UC 205	FL 205	0.60
	UCFL 205-16	5-1/8	3-57/64	5/8	3/4	1-1/16	5/8	2-43/64	1-13/32	1.3386	0.5630	1/2	UC 205-16	FL 205	0.59
30 1-1/8 1-1/4	UCFL 206	148	117	18	13	31.0	16	80	40.2	38.1	15.9	M 14	UC 206	FL 206	0.91
	UCFL 206-18	5-53/64	4-39/64	45/64	3/4	1-7/32	5/8	3-5/32	1-37/64	1.5000	0.6260	1/2	UC 206-18	FL 206	0.93
	UCFL 206-20	5-53/64	4-39/64	45/64	3/4	1-7/32	5/8	3-5/32	1-37/64	1.5000	0.6260	1/2	UC 206-20	FL 206	0.89
35 1-1/4 1-3/8	UCFL 207	161	130	19	14	34.0	16	90	44.4	42.9	17.5	M 14	UC 207	FL 207	1.14
	UCFL 207-20	6-11/32	5-1/8	3/4	35/64	1-11/32	5/8	3-35/64	1-3/4	1.6890	0.6890	1/2	UC 207-20	FL 207	1.20
	UCFL 207-22	6-11/32	5-1/8	3/4	35/64	1-11/32	5/8	3-35/64	1-3/4	1.6890	0.6890	1/2	UC 207-22	FL 207	1.15
40 1-1/2	UCFL 208	175	144	21	14	36.0	16	100	51.2	49.2	19.0	M 14	UC 208	FL 208	1.43
	UCFL 208-24	6-57/64	5-43/64	53/64	35/64	1-27/64	5/8	3-15/16	2-1/64	1.9370	0.7480	1/2	UC 208-24	FL 208	1.47
45 1-5/8	UCFL 209	188	148	22	16	38.0	19	108	52.2	49.2	19.0	M 16	UC 209	FL 209	1.80
	UCFL 209-26	7-13/32	5-53/64	55/64	5/8	1-1/2	3/4	4-1/4	2-1/16	1.9370	0.7480	5/8	UC 209-26	FL 209	1.90
50 1-7/8	UCFL 210	197	157	22	16	40.0	19	115	54.6	51.6	19.0	M 16	UC 210	FL 210	2.13
	UCFL 210-30	7-3/4	6-3/16	55/64	5/8	1-37/64	3/4	4-17/32	2-5/32	2.0315	0.7480	5/8	UC 210-30	FL 210	2.20
55 2	UCFL 211	224	184	25	18	43.0	19	130	58.4	55.6	22.2	M 16	UC 211	FL 211	2.86
	UCFL 211-32	8-13/16	7-1/4	63/64	45/64	1-11/16	3/4	5-1/8	2-19/64	2.1890	0.8740	5/8	UC 211-32	FL 211	3.01
60 2-1/4	UCFL 212	250	202	29	18	48.0	23	140	68.7	65.1	25.4	M 20	UC 212	FL 212	3.76
	UCFL 212-36	9-27/32	7-61/64	1-9/64	45/64	1-57/64	29/32	5-3/64	2-45/64	2.5630	1.0000	3/4	UC 212-36	FL 212	3.90
65 2-1/2	UCFL 213	258	210	30	20	50.0	23	155	69.7	65.1	25.4	M 20	UC 213	FL 213	4.63
	UCFL 213-40	10-5/32	8-17/64	1-3/16	25/32	1-31/32	29/32	6-7/64	2-3/4	2.5630	1.0000	3/4	UC 213-40	FL 213	4.71
70 2-3/4	UCFL 214	265	216	31	20	54.0	23	160	75.4	74.6	30.2	M 20	UC 214	FL 214	5.22
	UCFL 214-44	10-7/16	8-1/2	1-7/32	25/32	2-1/8	29/32	6-19/64	2-31/32	2.9370	1.1890	3/4	UC 214-44	FL 214	5.23
75 3	UCFL 215	275	225	34	22	55.0	23	164	78.5	77.8	33.3	M 20	UC 215	FL 215	5.36
	UCFL 215-48	10-53/64	8-55/64	1-11/32	25/32	2-13/64	29/32	6-1/2	3-3/32	3.0630	1.3110	3/4	UC 215-48	FL 215	5.28

Standard Duty Two Bolts Flanged Units Cast Housing Set Screws Type series UCFL 200

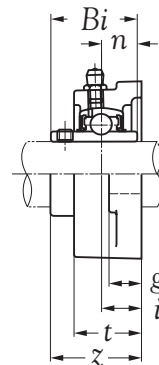
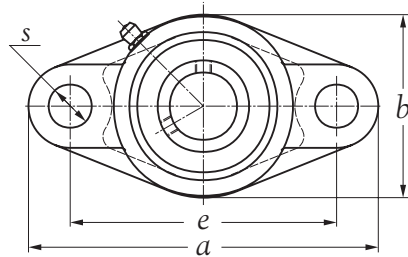

Shaft dia. mm inch	Unit number	Nominal dimensions										Bolt size mm inch	Bearing number	Housing number	Mass of unit kg
		a	e	i	g	t	s	b	z	Bi	n				
80 3-1/8	UCFL 216	290	233	34	22	58.0	25	180	83.3	82.6	33.3	M 22	UC 216	FL 216	6.99
	UCFL 216-50	11-27/64	9-11/64	1-11/32	55/64	2-9/32	63/64	7-3/32	3-9/32	3.2520	1.3110	7/8	UC 216-50	FL 216	7.04
85 3-1/4	UCFL 217	305	248	36	22	63.0	25	190	87.6	85.7	34.1	M 22	UC 217	FL 217	8.28
	UCFL 217-52	12-1/64	9-49/64	1-27/64	55/64	2-31/64	63/64	7-31/64	3-29/64	3.3740	1.3425	7/8	UC 217-52	FL 217	8.50
90 3-1/2	UCFL 218	320	265	40	23	68.0	25	205	96.3	96.0	39.7	M 22	UC 218	FL 218	10.70
	UCFL 218-56	12-19/32	10-7/16	1-37/64	29/32	2-43/64	63/64	8-5/64	3-51/64	3.7800	1.5630	7/8	UC 218-56	FL 218	10.81

Standard Duty Two Bolts Flanged Units Cast Housing Adapter Type series UKFL 200

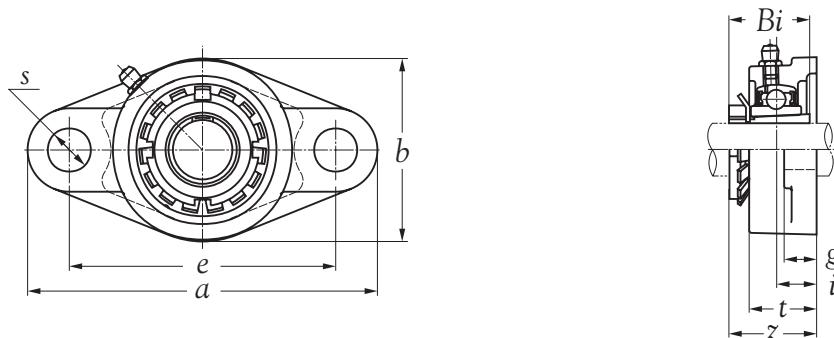

Shaft dia. mm	Unit number	Nominal dimensions									Bolt size mm	Bearing number	Housing number	Mass of unit kg
		<i>a</i>	<i>e</i>	<i>i</i>	<i>g</i>	<i>t</i>	<i>b</i>	<i>s</i>	<i>z</i>	<i>Bi</i>				
20	UKFL 205	130	99	16	13	27	68	16	35.5	35	M 14	UK 205	FL 205	0.54
25	UKFL 206	148	117	18	13	31	80	16	39.0	38	M 14	UK 206	FL 206	0.84
30	UKFL 207	161	130	19	14	34	90	16	42.5	43	M 14	UK 207	FL 207	1.04
35	UKFL 208	175	144	21	14	36	100	16	46.5	46	M 14	UK 208	FL 208	1.27
40	UKFL 209	188	148	22	16	38	108	19	48.5	50	M 16	UK 209	FL 209	1.65
45	UKFL 210	197	157	22	16	40	115	19	50.0	55	M 16	UK 210	FL 210	1.92
50	UKFL 211	224	184	25	18	43	130	19	54.5	59	M 16	UK 211	FL 211	2.51
55	UKFL 212	250	202	29	18	48	140	23	61.0	62	M 20	UK 212	FL 212	3.26
60	UKFL 213	258	210	30	20	50	155	23	64.0	65	M 20	UK 213	FL 213	4.13

Standard Duty Flanged Units Cast Housing Special Type Set Screws Type series UCFB 200

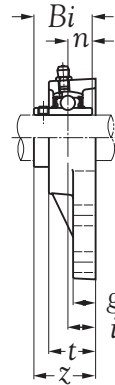
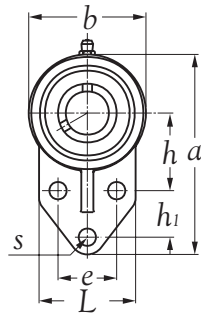

Shaft dia. mm inch	Unit number	Nominal dimensions													Bolt size mm inch	Bearing number	Housing number	Mass of unit kg
		mm inch																
		a	e	i	g	t	s	h	h ₁	L	b	z	Bi	n				
12 1/2	UCFB 201	109	32	15	11	25.5	10	42	27	52	60	33.3	31.0	12.7	M 8	UC 201	FB 204	0.53
	UCFB 201-8	4-19/64	1-17/64	19/32	7/16	1	25/64	1-21/32	1-1/16	2-1/16	2-23/64	1-5/16	1.2205	0.5000	5/16	UC 201-8		0.53
15 5/8	UCFB 202	109	32	15	11	25.5	10	42	27	52	60	33.3	31.0	12.7	M 8	UC 202	FB 204	0.52
	UCFB 202-10	4-19/64	1-17/64	19/32	7/16	1	25/64	1-21/32	1-1/16	2-1/16	2-43/64	1-5/16	1.2205	0.5000	5/16	UC 202-10		0.52
17 11/16	UCFB 203	109	32	15	11	25.5	10	42	27	52	60	33.3	31.0	12.7	M 8	UC 203	FB 204	0.51
	UCFB 203-11	4-19/64	1-17/64	19/32	7/16	1	25/64	1-21/32	1-1/16	2-1/16	2-43/64	1-5/16	1.2205	0.5000	5/16	UC 203-11		0.51
20 3/4	UCFB 204	109	32	15	11	25.5	10	42	27	52	60	33.3	31.0	12.7	M 8	UC 204	FB 204	0.49
	UCFB 204-12	4-19/64	1-17/64	19/32	7/16	1	25/64	1-21/32	1-1/16	2-1/16	2-43/64	1-5/16	1.2205	0.5000	5/16	UC 204-12		0.50
25 1	UCFB 205	116	34	16	13	27.0	10	45	27	56	68	35.7	34.0	14.3	M 8	UC 205	FB 205	0.66
	UCFB 205-16	4-9/16	1-11/32	5/8	3/4	1-1/16	25/64	1-49/64	1-1/16	2-13/64	2-43/64	1-13/32	1.3386	0.5630	5/16	UC 205-16		0.65
30 1-1/8 1-1/4	UCFB 206	132	40	18	13	31.0	10	50	29	65	80	40.2	38.1	15.9	M 8	UC 206	FB 206	0.99
	UCFB 206-18	5-13/64	1-37/64	45/64	3/4	1-7/32	25/64	1-31/32	1-9/64	2-9/16	3-5/32	1-37/64	1.5000	0.6260	5/16	UC 206-18		1.01
	UCFB 206-20															UC 206-20		0.97
35 1-1/4 1-3/8	UCFB 207	144	46	19	14	33.0	10	55	32	70	90	44.4	42.9	17.5	M 8	UC 207	FB 207	1.21
	UCFB 207-20	5-43/64	1-13/16	3/4	35/64	1-19/64	25/64	2-11/64	1-17/64	2-3/4	3-35/64	1-3/4	1.6890	0.6890	5/16	UC 207-20		1.27
	UCFB 207-22															UC 207-22		1.22
40 1-1/2	UCFB 208	164	50	21	16	35.0	12	60	41	78	100	51.2	49.2	19.0	M 10	UC 208	FB 208	1.72
	UCFB 208-24	6-29/64	1-31/32	53/64	5/8	1-3/8	15/32	2-23/64	1-39/64	3-5/64	3-15/16	2-1/64	1.9370	0.7480	3/8	UC 208-24		1.76
45 1-5/8	UCFB 209	175	54	22	16	38.0	12	65	43	80	108	52.2	49.2	19.0	M 10	UC 209	FB 209	1.86
	UCFB 209-26	6-57/64	2-1/8	55/64	5/8	1-1/2	15/32	2-9/16	1-11/16	3-5/32	4-1/4	2-1/16	1.9370	0.7480	3/8	UC 209-26		1.96
50 1-7/8	UCFB 210	184	58	22	16	39.0	12	68	46	86	114	54.6	51.6	19.0	M 10	UC 210	FB 210	2.36
	UCFB 210-30	7-1/4	2-9/32	55/64	5/8	1-17/32	15/32	2-43/64	1-13/16	3-25/64	4-31/64	2-5/32	2.0315	0.7480	3/8	UC 210-30		2.43
55 2	UCFB 211	207	62	25	18	42.5	14	78	50	90	128	58.4	55.6	22.2	M 12	UC 211	FB 211	3.11
	UCFB 211-32	8-5/32	2-7/16	63/64	45/64	1-43/64	35/64	3-5/64	1-31/32	3-35/64	5-1/16	2-19/64	2.1890	0.8740	7/16	UC 211-32		3.26
60 2-1/4	UCFB 212	224	66	29	19	47.5	14	84	55	94	140	68.7	65.1	25.4	M 12	UC 212	FB 212	4.07
	UCFB 212-36	8-13/16	2-19/32	1-9/64	3/4	1-7/8	35/64	3-5/16	2-11/64	3-45/64	5-3/64	2-45/64	2.5630	1.0000	7/16	UC 212-36		4.21
65 2-1/2	UCFB 213	244	70	30	20	49.0	14	92	60	102	152	69.7	65.1	25.4	M 12	UC 213	FB 213	4.86
	UCFB 213-40	9-39/64	2-3/4	1-3/16	25/32	1-59/64	35/64	3-5/8	2-23/64	4-1/64	5-63/64	2-3/4	2.5630	1.0000	7/16	UC 213-40		4.94

Standard Duty Flanged Units Cast Housing Set Screws Type series UCF 200

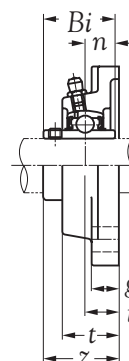
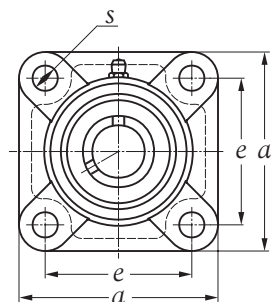

Shaft dia. mm inch	Unit number	Nominal dimensions										Bolt size mm inch	Bearing number	Housing number	Mass of unit kg
		mm inch													
		a	e	i	g	t	s	z	Bi	n					
12 1/2	UCF 201	86	64	15	12	25.5	12	33.3	31.0	12.7	M 10	UC 201	F 204	0.57	
	UCF 201-8	3-25/64	2-3/64	19/32	15/32	1	15/32	1-5/16	1.2205	0.5000	3/8	UC 201-8		0.57	
15 5/8	UCF 202	86	64	15	12	25.5	12	33.3	31.0	12.7	M 10	UC 202	F 204	0.56	
	UCF 202-10	3-25/64	2-3/64	19/32	15/32	1	15/32	1-5/16	1.2205	0.5000	3/8	UC 202-10		0.56	
17 11/16	UCF 203	86	64	15	12	25.5	12	33.3	31.0	12.7	M 10	UC 203	F 204	0.55	
	UCF 203-11	3-25/64	2-3/64	19/32	15/32	1	15/32	1-5/16	1.2205	0.5000	3/8	UC 203-11		0.55	
20 3/4	UCF 204	86	64	15	12	25.5	12	33.3	31.0	12.7	M 10	UC 204	F 204	0.53	
	UCF 204-12	3-25/64	2-3/64	19/32	15/32	1	15/32	1-5/16	1.2205	0.5000	3/8	UC 204-12		0.54	
25 1	UCF 205	95	70	16	13	27.0	12	35.7	34.0	14.3	M 10	UC 205	F 205	0.74	
	UCF 205-16	3-47/64	2-3/4	5/8	3/4	1-1/16	15/32	1-13/32	1.3386	0.5630	3/8	UC 205-16		0.73	
30 1-1/8 1-1/4	UCF 206	108	83	18	13	31.0	12	40.2	38.1	15.9	M 10	UC 206	F 206	1.05	
	UCF 206-18	4-1/4	3-17/64	45/64	3/4	1-7/32	15/32	1-37/64	1.5000	0.6260	3/8	UC 206-18		1.07	
	UCF 206-20											UC 206-20		1.03	
35 1-1/4 1-3/8	UCF 207	117	92	19	15	34.0	14	44.4	42.9	17.5	M 12	UC 207	F 207	1.34	
	UCF 207-20	4-39/64	3-5/8	3/4	19/32	1-11/32	35/64	1-3/4	1.6890	0.6890	7/16	UC 207-20		1.40	
	UCF 207-22											UC 207-22		1.35	
40 1-1/2	UCF 208	130	102	21	15	36.0	16	51.2	49.2	19.0	M 14	UC 208	F 208	1.77	
	UCF 208-24	5-1/8	4-1/64	53/64	19/32	1-27/64	5/8	2-1/64	1.9370	0.7480	1/2	UC 208-24		1.81	
45 1-5/8	UCF 209	137	105	22	16	38.0	16	52.2	49.2	19.0	M 14	UC 209	F 209	2.05	
	UCF 209-26	5-25/64	4-9/64	55/64	5/8	1-1/2	5/8	2-1/16	1.9370	0.7480	1/2	UC 209-26		2.15	
50 1-7/8	UCF 210	143	111	22	16	40.0	16	54.6	51.6	19.0	M 14	UC 210	F 210	2.35	
	UCF 210-30	5-5/8	4-3/8	55/64	5/8	1-37/64	5/8	2-5/32	2.0315	0.7480	1/2	UC 210-30		2.42	
55 2	UCF 211	162	130	25	18	43.0	19	58.4	55.6	22.2	M 16	UC 211	F 211	3.00	
	UCF 211-32	6-3/8	5-1/8	63/64	45/64	1-11/16	3/4	2-19/64	2.1890	0.8740	5/8	UC 211-32		3.15	
60 2-1/4	UCF 212	175	143	29	18	48.0	19	68.7	65.1	25.4	M 16	UC 212	F 212	3.57	
	UCF 212-36	6-57/64	5-5/8	1-9/64	45/64	1-57/64	3/4	2-45/64	2.5630	1.0000	5/8	UC 212-36		3.71	
65 2-1/2	UCF 213	187	149	30	22	50.0	19	69.7	65.1	25.4	M 16	UC 213	F 213	4.92	
	UCF 213-40	7-23/64	5-55/64	1-3/16	55/64	1-31/32	3/4	2-3/4	2.5630	1.0000	5/8	UC 213-40		5.00	
70 2-3/4	UCF 214	193	152	31	22	54.0	19	75.4	74.6	30.2	M 16	UC 214	F 214	5.62	
	UCF 214-44	7-19/32	5-63/64	1-7/32	55/64	2-1/8	3/4	2-31/32	2.9370	1.1890	5/8	UC 214-44		5.63	
75 3	UCF 215	200	159	34	22	56.0	19	78.5	77.8	33.3	M 16	UC 215	F 215	5.55	
	UCF 215-48	7-7/8	6-17/64	1-11/32	55/64	2-13/64	3/4	3-3/32	3.0630	1.3110	5/8	UC 215-48		5.47	

Standard Duty Flanged Units Cast Housing Set Screws Type series UCF 200

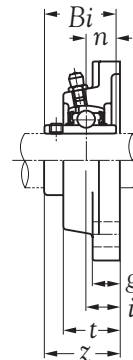
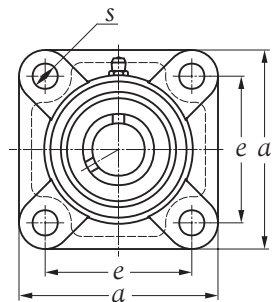

Shaft dia. mm inch	Unit number	Nominal dimensions									Bolt size mm inch	Bearing number	Housing number	Mass of unit kg
		<i>a</i>	<i>e</i>	<i>i</i>	<i>g</i>	<i>t</i>	<i>s</i>	<i>z</i>	<i>Bi</i>	<i>n</i>				
80 3-1/8	UCF 216	208	165	34	24	58.0	23	83.3	82.6	33.3	M 20	UC 216	F 216	6.99
	UCF 216-50	8-3/16	6-1/2	1-11/32	15/16	2-9/32	29/32	3-9/32	3.2520	1.3110	3/4	UC 216-50		7.04
85 3-1/4	UCF 217	220	175	36	26	63.0	23	87.6	85.7	34.1	M 20	UC 217	F 217	8.58
	UCF 217-52	8-21/32	6-57/64	1-27/64	1-1/64	2-31/64	29/32	3-29/64	3.3740	1.3425	3/4	UC 217-52		8.80
90 3-1/2	UCF 218	235	187	40	26	68.0	23	96.3	96.0	39.7	M 20	UC 218	F 218	11.20
	UCF 218-56	9-1/4	7-23/64	1-37/64	1-1/64	2-43/64	29/32	3-51/64	3.7800	1.5630	3/4	UC 218-56		11.31

Standard Duty Flanged Units Cast Housing Adapter Type series UKF 200

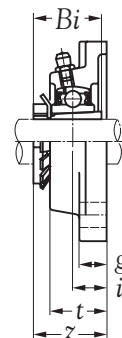
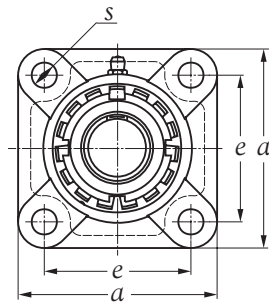

Shaft dia. mm	Unit number	Nominal dimensions								Bolt size mm	Bearing number	Housing number	Mass of unit kg
		inch											
		<i>a</i>	<i>e</i>	<i>i</i>	<i>g</i>	<i>t</i>	<i>s</i>	<i>z</i>	<i>Bi</i>				
20	UKF 205	95	70	16	13	27	12	35.5	35	M 10	UK 205	F 205	0.68
25	UKF 206	108	83	18	13	31	12	39.0	38	M 10	UK 206	F 206	0.98
30	UKF 207	117	92	19	15	34	14	42.5	43	M 12	UK 207	F 207	1.24
35	UKF 208	130	102	21	15	36	16	46.5	46	M 14	UK 208	F 208	1.61
40	UKF 209	137	105	22	16	38	16	48.5	50	M 14	UK 209	F 209	1.90
45	UKF 210	143	111	22	16	40	16	50.0	55	M 14	UK 210	F 210	2.14
50	UKF 211	162	130	25	18	43	19	54.5	59	M 16	UK 211	F 211	2.65
55	UKF 212	175	143	29	18	48	19	61.0	62	M 16	UK 212	F 212	3.07
60	UKF 213	187	149	30	22	50	19	64.0	65	M 16	UK 213	F 213	4.42

Standard Duty Flanged Units Cast Housing Special Type Set Screws Type series UCFA 200

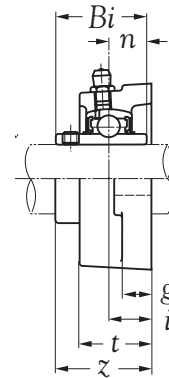
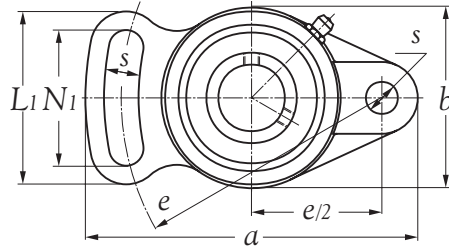

Shaft dia. mm inch	Unit number	Nominal dimensions												Bolt size mm inch	Bearing number	Housing number	Mass of unit kg
		a	e	i	g	t	s	N ₁	b	L ₁	z	Bi	n				
12 1/2	UCFA 201	102	78	15	12	25.5	10	40	60	54	33.3	31.0	12.7	M 8	UC 201	FA 204	0.49
	UCFA 201-8	4-1/64	3-5/64	19/32	15/32	1	25/64	1-37/64	2-23/64	2-1/8	1-5/16	1.2205	0.5000	5/16	UC 201-8		0.49
15 5/8	UCFA 202	102	78	15	12	25.5	10	40	60	54	33.3	31.0	12.7	M 8	UC 202	FA 204	0.48
	UCFA 202-10	4-1/64	3-5/64	19/32	15/32	1	25/64	1-37/64	2-23/64	2-1/8	1-5/16	1.2205	0.5000	5/16	UC 202-10		0.48
17 11/16	UCFA 203	102	78	15	12	25.5	10	40	60	54	33.3	31.0	12.7	M 8	UC 203	FA 204	0.47
	UCFA 203-11	4-1/64	3-5/64	19/32	15/32	1	25/64	1-37/64	2-23/64	2-1/8	1-5/16	1.2205	0.5000	5/16	UC 203-11		0.47
20 3/4	UCFA 204	102	78	15	12	25.5	10	40	60	54	33.3	31.0	12.7	M 8	UC 204	FA 204	0.45
	UCFA 204-12	4-1/64	3-5/64	19/32	15/32	1	25/64	1-37/64	2-23/64	2-1/8	1-5/16	1.2205	0.5000	5/16	UC 204-12		0.46
25 1	UCFA 205	125	98	16	14	27.0	12	51	68	65	34.7	34.0	14.3	M 10	UC 205	FA 205	0.64
	UCFA 205-16	4-59/64	3-55/64	5/8	35/64	1-1/16	15/32	2-1/64	2-43/64	2-9/16	1-23/64	1.3386	0.5630	3/8	UC 205-16		0.63
30 1-1/8 1-1/4	UCFA 206	144	117	18	14	31.0	12	58	80	72	40.2	38.1	15.9	M 10	UC 206	FA 206	0.92
	UCFA 206-18	5-43/64	4-39/64	45/64	35/64	1-7/32	15/32	2-9/32	3-5/32	2-53/64	1-37/64	1.5000	0.6260	3/8	UC 206-18		0.94
	UCFA 206-20														UC 206-20		0.90
35 1-1/4 1-3/8	UCFA 207	161	130	19	16	34.0	14	66	90	82	45.4	42.9	17.5	M 12	UC 207	FA 207	1.27
	UCFA 207-20	6-11/32	5-1/8	3/4	5/8	1-11/32	35/64	2-19/32	3-35/64	3-15/64	1-25/32	1.6890	0.6890	7/16	UC 207-20		1.33
	UCFA 207-22														UC 207-22		1.28
40 1-1/2	UCFA 208	175	144	21	16	36.0	14	71	100	87	52.2	49.2	19.0	M 12	UC 208	FA 208	1.62
	UCFA 208-24	6-57/64	5-43/64	53/64	5/8	1-27/64	35/64	2-51/64	3-15/16	3-27/64	2-1/16	1.9370	0.7480	7/16	UC 208-24		1.66
45 1-5/8	UCFA 209	178	146	22	16	38.0	16	72	108	88	52.2	49.2	19.0	M 14	UC 209	FA 209	1.84
	UCFA 209-26	7-1/64	5-3/4	55/64	5/8	1-1/2	5/8	2-53/64	4-1/4	3-15/32	2-1/16	1.9370	0.7480	1/2	UC 209-26		1.94
50 1-7/8	UCFA 210	188	155	22	16	39.0	16	75	114	92	54.6	51.6	19.0	M 14	UC 210	FA 210	2.10
	UCFA 210-30	7-13/32	6-7/64	55/64	5/8	1-17/32	5/8	2-61/64	4-31/64	3-5/8	2-5/32	2.0315	0.7480	1/2	UC 210-30		2.17
55 2	UCFA 211	216	182	25	18	42.5	16	84	128	102	58.4	55.6	22.2	M 14	UC 211	FA 211	2.16
	UCFA 211-32	8-1/2	7-11/64	63/64	45/64	1-43/64	5/8	3-5/16	5-1/16	4-1/64	2-19/64	2.1890	0.8740	1/2	UC 211-32		2.31
60 2-1/4	UCFA 212	238	202	29	19	47.5	18	104	140	122	68.7	65.1	25.4	M 16	UC 212	FA 212	2.92
	UCFA 212-36	9-3/8	7-61/64	1-9/64	3/4	1-7/8	45/64	4-3/32	5-3/64	4-51/64	2-45/64	2.5630	1.0000	5/8	UC 212-36		3.06
65 2-1/2	UCFA 213	248	210	30	20	49.0	18	106	152	126	69.7	65.1	25.4	M 16	UC 213	FA 213	3.61
	UCFA 213-40	9-49/64	8-17/64	1-3/16	25/32	1-59/64	45/64	4-11/64	5-63/64	4-61/64	2-3/4	2.5630	1.0000	5/8	UC 213-40		3.69

Standard Duty Flanged Cartridge Units Cast Housing Set Screws Type series UCFC 200

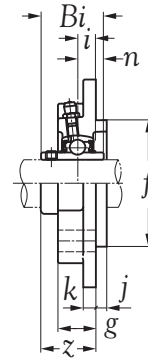
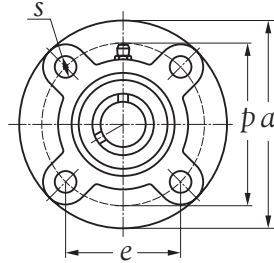

Shaft dia. mm inch	Unit number	Nominal dimensions												Bolt size mm inch	Bearing number	Housing number	Mass of unit kg
		a	p	e	i	s	j	k	g	f	z	Bi	n				
12 1/2	UCFC 201	100	78	55.1	10	12	5	6	20.5	62	28.3	31.0	12.7	M 10	UC 201	FC 204	0.73
	UCFC 201-8	3-15/16	3-5/64	2-11/64	25/64	15/32	13/64	15/64	13/16	2-7/16	1-7/64	1.2205	0.5000	3/8	UC 201-8		0.73
15 5/8	UCFC 202	100	78	55.1	10	12	5	6	20.5	62	28.3	31.0	12.7	M 10	UC 202	FC 204	0.72
	UCFC 202-10	3-15/16	3-5/64	2-11/64	25/64	15/32	13/64	15/64	13/16	2-7/16	1-7/64	1.2205	0.5000	3/8	UC 202-10		0.72
17 11/16	UCFC 203	100	78	55.1	10	12	5	6	20.5	62	28.3	31.0	12.7	M 10	UC 203	FC 204	0.71
	UCFC 203-11	3-15/16	3-5/64	2-11/64	25/64	15/32	13/64	15/64	13/16	2-7/16	1-7/64	1.2205	0.5000	3/8	UC 203-11		0.71
20 3/4	UCFC 204	100	78	55.1	10	12	5	6	20.5	62	28.3	31.0	12.7	M 10	UC 204	FC 204	0.69
	UCFC 204-12	3-15/16	3-5/64	2-11/64	25/64	15/32	13/64	15/64	13/16	2-7/16	1-7/64	1.2205	0.5000	3/8	UC 204-12		0.70
25 1	UCFC 205	115	90	63.6	10	12	6	7	21.0	70	29.7	34.0	14.3	M 10	UC 205	FC 205	0.99
	UCFC 205-16	4-17/32	3-35/64	2-1/2	25/64	15/32	15/64	9/32	53/64	2-3/4	1-11/64	1.3386	0.5630	3/8	UC 205-16		0.98
30 1-1/8 1-1/4	UCFC 206	125	100	70.7	10	12	8	8	23.0	80	32.2	38.1	15.9	M 10	UC 206	FC 206	1.25
	UCFC 206-18	4-59/64	3-15/16	2-25/32	25/64	15/32	5/16	5/16	29/32	3-5/32	1-17/64	1.5000	0.6260	3/8	UC 206-18		1.27
	UCFC 206-20														UC 206-20		1.23
35 1-1/4 1-3/8	UCFC 207	135	110	77.8	11	14	8	9	26.0	90	36.4	42.9	17.5	M 12	UC 207	FC 207	1.64
	UCFC 207-20	5-5/16	4-21/64	3-1/16	7/16	35/64	5/16	23/64	1-1/64	3-35/64	1-7/16	1.6890	0.6890	7/16	UC 207-20		1.70
	UCFC 207-22														UC 207-22		1.65
40 1-1/2	UCFC 208	145	120	84.8	11	14	10	9	26.0	100	41.2	49.2	19.0	M 12	UC 208	FC 208	2.01
	UCFC 208-24	5-45/64	4-23/32	3-11/32	7/16	35/64	25/64	23/64	1-1/64	3-15/16	1-5/8	1.9370	0.7480	7/16	UC 208-24		2.05
45 1-5/8	UCFC 209	160	132	93.3	10	16	12	10	26.0	105	40.2	49.2	19.0	M 14	UC 209	FC 209	2.57
	UCFC 209-26	6-19/64	5-13/64	3-43/64	25/64	5/8	15/32	25/64	1-1/64	4-9/64	1-37/64	1.9370	0.7480	1/2	UC 209-26		2.67
60 1-7/8	UCFC 210	165	138	97.6	10	16	12	14	28.0	110	42.6	51.6	19.0	M 14	UC 210	FC 210	2.85
	UCFC 210-30	6-1/2	5-7/16	3-27/32	25/64	5/8	15/32	35/64	1-7/64	4-21/64	1-43/64	2.0315	0.7480	1/2	UC 210-30		2.92
55 2	UCFC 211	185	150	106.1	13	19	12	13	30.0	125	46.4	55.6	22.2	M 16	UC 211	FC 211	3.92
	UCFC 211-32	7-9/32	5-29/32	4-11/64	3/64	3/4	15/32	3/64	1-3/16	4-59/64	1-53/64	2.1890	0.8740	5/8	UC 211-32		4.07
60 2-1/4	UCFC 212	195	160	113.1	17	19	12	15	36.0	135	56.7	65.1	25.4	M 16	UC 212	FC 212	5.03
	UCFC 212-36	7-43/64	6-19/64	4-29/64	43/64	3/4	15/32	19/32	1-27/64	5-5/16	2-15/64	2.5630	1.0000	5/8	UC 212-36		5.17
65 2-1/2	UCFC 213	205	170	120.2	16	19	14	15	35.0	145	55.7	65.1	25.4	M 16	UC 213	FC 213	5.52
	UCFC 213-40	8-5/64	6-11/16	4-47/64	5/8	3/4	35/64	19/32	1-3/8	5-45/64	2-3/16	2.5630	1.0000	5/8	UC 213-40		5.60
70 2-3/4	UCFC 214	215	177	125.1	17	19	14	16	38.0	150	61.4	74.6	30.2	M 16	UC 214	FC 214	6.55
	UCFC 214-44	8-15/32	6-31/32	4-59/64	43/64	3/4	35/64	5/8	1-1/2	5-29/32	2-27/64	2.9370	1.1890	5/8	UC 214-44		6.56
75 3	UCFC 215	220	184	130.1	18	19	16	17	39.0	160	62.5	77.8	33.3	M 16	UC 215	FC 215	7.01
	UCFC 215-48	8-21/32	7-1/4	5-1/8	45/64	3/4	5/8	43/64	1-17/32	6-19/64	2-29/64	3.0630	1.3110	5/8	UC 215-48		6.93

Standard Duty Flanged Cartridge Units Cast Housing Set Screws Type series UCFC 200

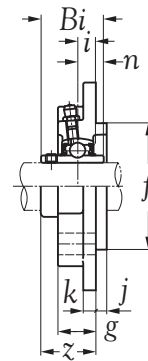
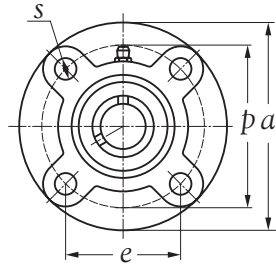

Shaft dia. mm inch	Unit number	Nominal dimensions												Bolt size mm inch	Bearing number	Housing number	Mass of unit kg
		mm inch															
		a	p	e	i	s	j	k	g	f	z	Bi	n				
80 3-1/8	UCFC 216 UCFC 216-50	240 9-29/64	200 7-7/8	141.4 5-9/16	18 45/64	23 29/32	16 5/8	18 45/64	42.0 1-21/32	170 6-11/16	67.3 2-21/32	82.6 3.2520	33.3 1.3110	M 20 3/4	UC 216 UC 216-50	FC 216	8.94 8.99
85 3-1/4	UCFC 217 UCFC 217-52	250 9-27/32	208 8-3/16	147.1 5-51/64	18 45/64	23 29/32	18 45/64	20 25/32	45.0 1-49/64	180 7-3/32	69.6 2-47/64	85.7 3.3740	34.1 1.3425	M 20 3/4	UC 217 UC 217-52	FC 217	10.68 10.90
90 3-1/2	UCFC 218 UCFC 218-56	265 10-7/16	220 8-21/32	155.5 6-1/8	22 55/64	23 29/32	18 45/64	20 25/32	50.0 1-31/32	190 7-31/64	78.3 3-5/64	96.0 3.7800	39.7 1.5630	M 20 3/4	UC 218 UC 218-56	FC 218	12.95 13.06

Standard Duty Flanged Cartridge Units Housing Adapter Type series UKFC 200

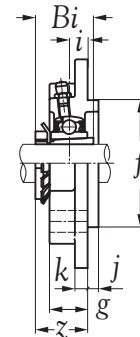
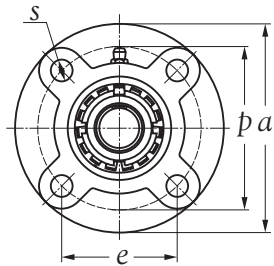

Shaft dia. mm	Unit number	Nominal dimensions											Bolt size mm	Bearing number	Housing number	Mass of unit kg
		<i>a</i>	<i>p</i>	<i>e</i>	<i>i</i>	<i>s</i>	mm			<i>j</i>	<i>k</i>	<i>g</i>				
20	UKFC 205	115	90	63.6	10	12	6	7	21	70	29.5	35	M 10	UK 205	FC 205	0.93
25	UKFC 206	125	100	70.7	10	12	8	8	23	80	31.0	38	M 10	UK 206	FC 206	1.18
30	UKFC 207	135	110	77.8	11	14	8	9	26	90	34.5	43	M 12	UK 207	FC 207	1.54
35	UKFC 208	145	120	84.8	11	14	10	9	26	100	36.5	46	M 12	UK 208	FC 208	1.85
40	UKFC 209	160	132	93.3	10	16	12	10	26	105	36.5	50	M 14	UK 209	FC 209	2.42
45	UKFC 210	165	138	97.6	10	16	12	14	28	110	38.0	55	M 14	UK 210	FC 210	2.64
50	UKFC 211	185	150	106.1	13	19	12	13	30	125	42.5	59	M 16	UK 211	FC 211	3.57
55	UKFC 212	195	160	113.1	17	19	12	15	36	135	49.0	62	M 16	UK 212	FC 212	4.53
60	UKFC 213	205	170	120.2	16	19	14	15	35	145	50.0	65	M 16	UK 213	FC 213	5.02

Standard Duty Take-up Units Cast Housing Set Screws Type series UCT 200

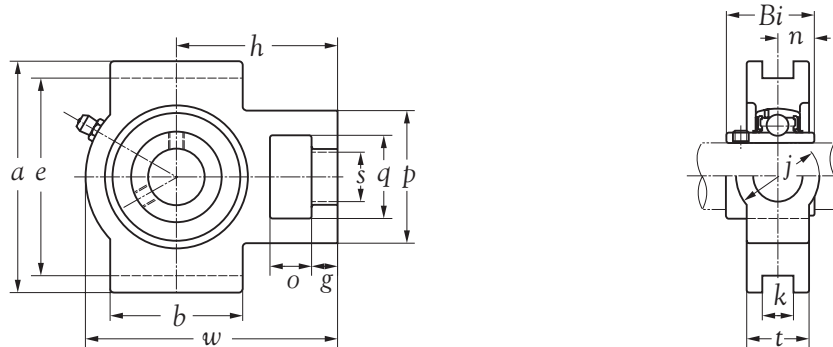

Shaft dia. mm inch	Unit number	Nominal dimensions															Bearing number	Housing number	Mass of unit kg
		mm inch																	
		o	g	p	q	s	b	k	e	a	w	j	t	h	Bi	n			
12 1/2	UCT 201	16	10	51	32	19	51	12	76	89	94	32	21	61	31.0	12.7	UC 201	T 204	0.77
	UCT 201-8	5/8	25/64	2-1/64	1-17/64	3/4	2-1/64	15/32	2-63/64	3-1/2	3-45/64	1-17/64	53/64	2-13/32	1.2205	0.5000	UC 201-8		0.77
15 5/8	UCT 202	16	10	51	32	19	51	12	76	89	94	32	21	61	31.0	12.7	UC 202	T 204	0.76
	UCT 202-10	5/8	25/64	2-1/64	1-17/64	3/4	2-1/64	15/32	2-63/64	3-1/2	3-45/64	1-17/64	53/64	2-13/32	1.2205	0.5000	UC 202-10		0.76
17 11/16	UCT 203	16	10	51	32	19	51	12	76	89	94	32	21	61	31.0	12.7	UC 203	T 204	0.75
	UCT 203-11	5/8	25/64	2-1/64	1-17/64	3/4	2-1/64	15/32	2-63/64	3-1/2	3-45/64	1-17/64	53/64	2-13/32	1.2205	0.5000	UC 203-11		0.75
20 3/4	UCT 204	16	10	51	32	19	51	12	76	89	94	32	21	61	31.0	12.7	UC 204	T 204	0.73
	UCT 204-12	5/8	25/64	2-1/64	1-17/64	3/4	2-1/64	15/32	2-63/64	3-1/2	3-45/64	1-17/64	53/64	2-13/32	1.2205	0.5000	UC 204-12		0.74
25 1	UCT 205	16	10	51	32	19	51	12	76	89	97	32	24	62	34.0	14.3	UC 205	T 205	0.83
	UCT 205-16	5/8	25/64	2-1/64	1-17/64	3/4	2-1/64	15/32	2-63/64	3-1/2	3-13/16	1-17/64	15/16	2-7/16	1.3385	0.5630	UC 205-16		0.82
30 1-1/8 1-1/4	UCT 206	16	10	56	37	22	57	12	89	102	113	37	28	70	38.1	15.9	UC 206	T 206	1.26
	UCT 206-18	5/8	25/64	2-13/64	1-29/64	55/64	2-1/4	15/32	3-1/2	4-1/64	4-29/64	1-29/64	1-7/64	2-3/4	1.5000	0.6260	UC 206-18		1.28
	UCT 206-20	5/8	25/64	2-13/64	1-29/64	55/64	2-1/4	15/32	3-1/2	4-1/64	4-29/64	1-29/64	1-7/64	2-3/4	1.5000	0.6260	UC 206-20		1.24
35 1-1/4 1-3/8	UCT 207	16	13	64	37	22	64	12	89	102	129	37	30	78	42.9	17.5	UC 207	T 207	1.58
	UCT 207-20	5/8	3/64	2-3/64	1-29/64	55/64	2-3/64	15/32	3-1/2	4-1/64	5-5/64	1-29/64	1-3/16	3-5/64	1.6890	0.6890	UC 207-20		1.64
	UCT 207-22	5/8	3/64	2-3/64	1-29/64	55/64	2-3/64	15/32	3-1/2	4-1/64	5-5/64	1-29/64	1-3/16	3-5/64	1.6890	0.6890	UC 207-22		1.59
40 1-1/2	UCT 208	19	16	83	49	29	83	16	102	114	144	49	33	88	49.2	19.0	UC 208	T 208	2.31
	UCT 208-24	3/4	5/8	3-17/64	1-59/64	1-9/64	3-17/64	5/8	4-1/64	4-31/64	5-43/64	1-59/64	1-19/64	3-15/32	1.9370	0.7480	UC 208-24		2.35
45 1-5/8	UCT 209	19	16	83	49	29	83	16	102	117	144	49	35	87	49.2	19.0	UC 209	T 209	2.28
	UCT 209-26	3/4	5/8	3-17/64	1-59/64	1-9/64	3-17/64	5/8	4-1/64	4-39/64	5-43/64	1-59/64	1-3/8	3-27/64	1.9370	0.7480	UC 209-26		2.38
50 1-7/8	UCT 210	19	16	83	49	29	86	16	102	117	149	49	37	90	51.6	19.0	UC 210	T 210	2.50
	UCT 210-30	3/4	5/8	3-17/64	1-59/64	1-9/64	3-25/64	5/8	4-1/64	4-39/64	5-55/64	1-59/64	1-29/64	3-35/64	2.0315	0.7480	UC 210-30		2.57
55 2	UCT 211	25	19	102	64	35	95	22	130	146	171	64	38	106	55.6	22.2	UC 211	T 211	3.79
	UCT 211-32	63/64	3/4	4-1/64	2-3/64	1-3/8	3-47/64	55/64	5-1/8	5-3/4	6-47/64	2-3/64	1-1/2	4-11/64	2.1890	0.8740	UC 211-32		3.94
60 2-1/4	UCT 212	32	19	102	64	35	102	22	130	146	194	64	42	119	65.1	25.4	UC 212	T 212	4.79
	UCT 212-36	1-17/64	3/4	4-1/64	2-3/64	1-3/8	4-1/64	55/64	5-1/8	5-3/4	7-41/64	2-3/64	1-21/32	4-11/16	2.5630	1.0000	UC 212-36		4.93
65 2-1/2	UCT 213	32	21	111	70	41	121	26	151	167	224	70	44	137	65.1	25.4	UC 213	T 213	6.66
	UCT 213-40	1-17/64	53/64	4-3/8	2-3/4	1-39/64	4-49/64	1-1/64	5-15/16	6-37/64	8-13/16	2-3/4	1-47/64	5-25/64	2.5630	1.0000	UC 213-40		6.74
70 2-3/4	UCT 214	32	21	111	70	41	121	26	151	167	224	70	46	137	74.6	30.2	UC 214	T 214	6.75
	UCT 214-44	1-17/64	53/64	4-3/8	2-3/4	1-39/64	4-49/64	1-1/64	5-15/16	6-37/64	8-13/16	2-3/4	1-13/16	5-25/64	2.9370	1.1890	UC 214-44		6.76
75 3	UCT 215	32	21	111	70	41	121	26	151	167	232	70	48	140	77.8	33.3	UC 215	T 215	7.11
	UCT 215-48	1-17/64	53/64	4-3/8	2-3/4	1-39/64	4-49/64	1-1/64	5-15/16	6-37/64	9-9/64	2-3/4	1-57/64	5-3/64	3.0630	1.3110	UC 215-48		7.03

Standard Duty Take-up Units Cast Housing Set Screws Type series UCT 200

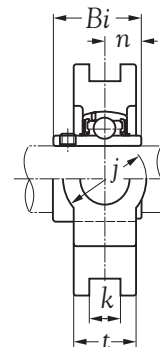
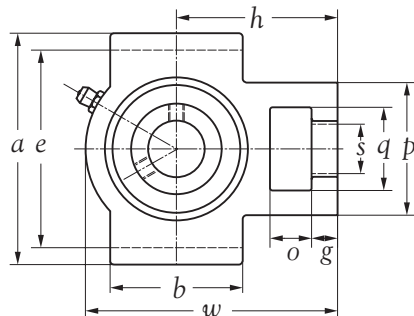

Shaft dia. mm inch	Unit number	Nominal dimensions															Bearing number	Housing number	Mass of unit kg
		mm inch																	
		o	g	p	q	s	b	k	e	a	w	j	t	h	Bi	n			
80	UCT 216	32	21	111	70	41	121	26	165	184	235	70	51	140	82.6	33.3	UC 216	T 216	8.19
3-1/8	UCT 216-50	1-17/64	53/64	4-3/8	2-3/4	1-39/64	4-49/64	1-1/64	6-1/2	7-1/4	9-1/4	2-3/4	2-1/64	5-3/64	3.2520	1.3110	UC 216-50		8.24
85	UCT 217	38	29	124	73	48	157	30	173	198	260	73	54	162	85.7	34.1	UC 217	T 217	10.58
3-1/4	UCT 217-52	1-1/2	1-9/64	4-7/8	2-7/8	1-57/64	6-3/16	1-3/16	6-13/16	7-51/64	10-15/64	2-7/8	2-1/8	6-3/8	3.3740	1.3425	UC 217-52		10.80



Standard Duty Hanger Units Set Screws Type series UCHA 200

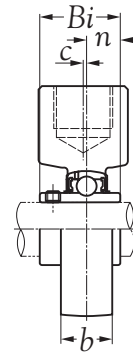
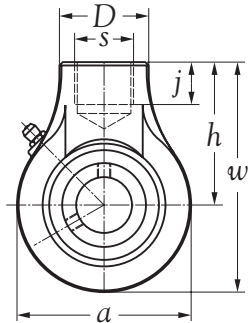

Shaft dia. mm inch	Unit number	Nominal dimensions										Bearing number	Housing number	Mass of unit kg
		mm inch												
		a	w	c	b	h	s	D	j	Bi	n			
12 1/2	UCHA 201	64	96.0	0	22	64	RP 3/4	40	19	31.0	12.7	UC 201	HA 204	0.66
	UCHA 201-8	2-3/64	3-25/32	0	55/64	2-3/64	RP 3/4	1-37/64	3/4	1.2205	0.5000	UC 201-8		0.66
15 5/8	UCHA 202	64	96.0	0	22	64	RP 3/4	40	19	31.0	12.7	UC 202	HA 204	0.65
	UCHA 202-10	2-3/64	3-25/32	0	55/64	2-3/64	RP 3/4	1-37/64	3/4	1.2205	0.5000	UC 202-10		0.65
17 11/16	UCHA 203	64	96.0	0	22	64	RP 3/4	40	19	31.0	12.7	UC 203	HA 204	0.64
	UCHA 203-11	2-3/64	3-25/32	0	55/64	2-3/64	RP 3/4	1-37/64	3/4	1.2205	0.5000	UC 203-11		0.64
20 3/4	UCHA 204	64	96.0	0	22	64	RP 3/4	40	19	31.0	12.7	UC 204	HA 204	0.62
	UCHA 204-12	2-3/64	3-25/32	0	55/64	2-3/64	RP 3/4	1-37/64	3/4	1.2205	0.5000	UC 204-12		0.63
25 1	UCHA 205	78	103.0	0	23	64	RP 3/4	40	19	34.0	14.3	UC 205	HA 205	0.83
	UCHA 205-16	3-5/64	4-1/16	0	29/32	2-3/64	RP 3/4	1-37/64	3/4	1.3386	0.5630	UC 205-16		0.82
30 1-1/8 1-1/4	UCHA 206	78	103.0	0	25	64	RP 3/4	40	19	38.1	15.9	UC 206	HA 206	0.78
	UCHA 206-18	3-5/64	4-1/16	0	63/64	2-3/64	RP 3/4	1-37/64	3/4	1.5000	0.6260	UC 206-18		0.80
	UCHA 206-20				UC 206-20	0.76								
35 1-1/4 1-3/8	UCHA 207	92	116.0	0	26	70	RP 3/4	40	19	42.9	17.5	UC 207	HA 207	1.11
	UCHA 207-20	3-5/8	4-9/16	0	1-1/64	2-3/4	RP 3/4	1-37/64	3/4	1.6890	0.6890	UC 207-20		1.17
	UCHA 207-22				UC 207-22	1.12								
40 1-1/2	UCHA 208	96	121.0	2.0	30	73	RP 3/4	40	19	49.2	19.0	UC 208	HA 208	1.25
	UCHA 208-24	3-25/32	4-49/64	5/64	1-3/16	2-7/8	RP 3/4	1-37/64	3/4	1.9370	0.7480	UC 208-24		1.29
45 1-5/8	UCHA 209	108	136.0	5.0	30	82	RP 1	48	21	49.2	19.0	UC 209	HA 209	1.65
	UCHA 209-26	4-1/4	5-23/64	13/64	1-3/16	3-15/64	RP 1	1-57/64	53/64	1.9370	0.7480	UC 209-26		1.75
50 1-7/8	UCHA 210	115	140.5	5.0	32	83	RP 1	48	21	51.6	19.0	UC 210	HA 210	1.95
	UCHA 210-30	4-17/32	5-17/32	13/64	1-17/64	3-17/64	RP 1	1-57/64	53/64	2.0315	0.7480	UC 210-30		2.02
55 2	UCHA 211	126	150.0	7.0	33	87	RP 1-1/4	60	24	55.6	22.2	UC 211	HA 211	2.48
	UCHA 211-32	4-61/64	5-29/32	9/32	1-19/64	3-27/64	RP 1-1/4	2-23/64	15/16	2.1890	0.874	UC 211-32		2.63
60 2-1/4	UCHA 212	142	173.0	9.0	36	102	RP 1-1/4	60	28	65.1	25.4	UC 212	HA 212	3.59
	UCHA 212-36	5-19/32	6-13/16	23/64	1-27/64	4-1/64	RP 1-1/4	2-23/64	1-7/64	2.5630	1.0000	UC 212-36		3.73
65 2-1/2	UCHA 213	166	200.0	9.5	38	117	RP 1-1/2	70	32	65.1	25.4	UC 213	HA 213	5.37
	UCHA 213-40	6-17/32	7-7/8	3/8	1-1/2	4-39/64	RP 1-1/2	2-3/4	1-17/64	2.5630	1.0000	UC 213-40		5.45

Standard Duty Spherical Outside Surface Ball Bearings Set Screws Type series UC 200

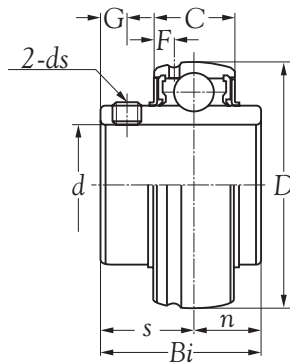

Shaft dia. mm inch	Bearing number	Nominal dimensions									Basic load ratings N		Mass kg
		d	D	Bi	C	mm inch		G	F	ds	dynamic Cr	static Cor	
						n	s						
12	UC 201	12	47	31.0	16	12.7	18.3	5.0	3.5	M 5X0.8	12800	6650	0.21
1/2	UC 201-8	0.5000	1.8504	1.2205	0.6299	0.5000	0.7205	0.1969	0.1378	M 5X0.8	12800	6650	0.21
15	UC 202	15	47	31.0	16	12.7	18.3	5.0	3.5	M 5X0.8	12800	6650	0.20
5/8	UC 202-10	0.6250	1.8504	1.2205	0.6299	0.5000	0.7205	0.1969	0.1378	M 5X0.8	12800	6650	0.20
17	UC 203	17	47	31.0	16	12.7	18.3	5.0	3.5	M 5X0.8	12800	6650	0.19
11/16	UC 203-11	0.6875	1.8504	1.2205	0.6299	0.5000	0.7205	0.1969	0.1378	M 5X0.8	12800	6650	0.19
20	UC 204	20	47	31.0	16	12.7	18.3	5.0	3.5	M 6X0.75	12800	6650	0.17
3/4	UC 204-12	0.7500	1.8504	1.2205	0.6299	0.5000	0.7205	0.1969	0.1378	M 6X0.75	12800	6650	0.18
25	UC 205	25	52	34.0	17	14.3	19.7	5.5	4.0	M 6X0.75	14000	7850	0.21
1	UC 205-16	1.0000	2.0472	1.3386	0.6693	0.5630	0.7756	0.2165	0.1575	M 6X0.75	14000	7850	0.20
30	UC 206	30	62	38.1	19	15.9	22.2	5.5	4.2	M 6X0.75	19500	11300	0.32
1-1/8	UC 206-18	1.1250	2.4409	1.5000	0.7480	0.6260	0.8740	0.2362	0.1654	M 6X0.75	19500	11300	0.34
1-1/4	UC 206-20	1.2500	2.4409	1.5000	0.7480	0.6260	0.8740	0.2362	0.1654	M 6X0.75	19500	11300	0.30
35	UC 207	35	72	42.9	20	17.5	25.4	6.5	4.3	M 8X1	25700	15300	0.47
1-1/4	UC 207-20	1.2500	2.8346	1.6890	0.7874	0.6890	1.0000	0.2559	0.1693	M 8X1	25700	15300	0.53
1-3/8	UC 207-22	1.3750	2.8346	1.6890	0.7874	0.6890	1.0000	0.2559	0.1693	M 8X1	25700	15300	0.48
40	UC 208	40	80	49.2	21	19.0	30.2	8.0	4.2	M 8X1	29100	17800	0.64
1-1/2	UC 208-24	1.5000	3.1496	1.9370	0.8268	0.7480	1.1890	0.3150	0.1654	M 8X1	29100	17800	0.68
45	UC 209	45	85	49.2	22	19.0	30.2	8.0	4.2	M 8X1	32500	20400	0.68
1-5/8	UC 209-26	1.6250	3.3465	1.9370	0.8661	0.7480	1.1890	0.3150	0.1654	M 8X1	32500	20400	0.78
50	UC 210	50	90	51.6	23	19.0	32.6	9.0	4.8	M 10X1.25	35000	23200	0.80
1-7/8	UC 210-30	1.8750	3.5433	2.0315	0.9055	0.7480	1.2835	0.3543	0.1890	M 10X1.25	35000	23200	0.87
55	UC 211	55	100	55.6	25	22.2	33.4	9.0	5.3	M 10X1.25	43500	29200	1.12
2	UC 211-32	2.0000	3.9370	2.1890	0.9843	0.8740	1.3150	0.3543	0.2087	M 10X1.25	43500	29200	1.27
60	UC 212	60	110	65.1	27	25.4	39.7	10.5	5.3	M 10X1.25	52500	36000	1.53
2-1/4	UC 212-36	2.2500	4.3307	2.5630	1.0630	1.0000	1.5630	0.4134	0.2087	M 10X1.25	52500	36000	1.67
65	UC 213	65	120	65.1	28	25.4	39.7	12.0	6.0	M 10X1.25	57500	40000	1.86
2-1/2	UC 213-40	2.5000	4.7244	2.5630	1.1024	1.0000	1.5630	0.4724	0.2362	M 10X1.25	57500	40000	1.94
70	UC 214	70	125	74.6	30	30.2	44.4	12.0	6.0	M 12X1.5	62000	44000	2.05
2-3/4	UC 214-44	2.7500	4.9213	2.9370	1.1811	1.1890	1.7480	0.4724	0.2362	M 12X1.5	62000	44000	2.06
75	UC 215	75	130	77.8	30	33.3	44.5	12.0	6.0	M 12X1.5	66000	49500	2.21
3	UC 215-48	3.0000	5.1181	3.0630	1.1811	1.3110	1.7520	0.4724	0.2362	M 12X1.5	66000	49500	2.13

Standard Duty Spherical Outside Surface Ball Bearings Set Screws Type series UC 200

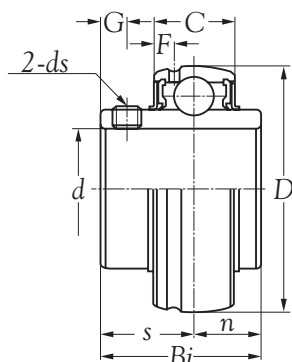

Shaft dia. mm inch	Bearing number	Nominal dimensions									Basic load ratings N		Mass kg
		<i>d</i>	<i>D</i>	<i>Bi</i>	<i>C</i>	mm inch		<i>G</i>	<i>F</i>	<i>ds</i>	dynamic <i>Cr</i>	static <i>Cor</i>	
						<i>n</i>	<i>s</i>						
80 3-1/8	UC 216 UC 216-50	80 3.1250	140 5.5118	82.6 3.2520	33 1.2992	33.3 1.3110	49.3 1.9409	14.0 0.5512	6.3 0.2480	M 12X1.5	72500	53000	2.79 2.84
85 3-1/4	UC 217 UC 217-52	85 3.2500	150 5.9055	85.7 3.3740	35 1.3780	34.1 1.3425	51.6 2.0315	14.0 0.5512	6.5 0.2559	M 12X1.5	83500	64000	3.38 3.60
90 3-1/2	UC 218 UC 218-56	90 3.5000	160 6.2992	96.0 3.7795	37 1.4567	39.7 1.5630	56.3 2.2165	14.0 0.5512	6.5 0.2559	M 12X1.5	96000	71500	4.45 4.56

Standard Duty Spherical Outside Surface Ball Bearings Adapter Type series UK 200

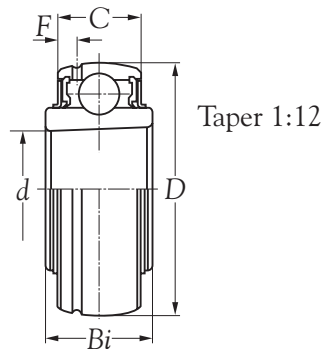

Shaft dia. mm	Bearing number	Nominal dimensions					Basic load ratings		Mass kg
		<i>d</i>	<i>D</i>	<i>Bi</i>	<i>C</i>	<i>F</i>	N dynamic Cr	N static Cor	
20	UK 205	25	52	21	17	4.2	14000	7850	0.15
25	UK 206	30	62	25	19	4.5	19500	11300	0.25
30	UK 207	35	72	27	20	4.2	25700	15300	0.37
35	UK 208	40	80	29	21	4.2	29100	17800	0.48
40	UK 209	45	85	30	22	4.2	32500	20400	0.53
45	UK 210	50	90	31	23	5.0	35000	23200	0.59
50	UK 211	55	100	33	27	6.3	43500	29200	0.77
55	UK 212	60	110	36	27	5.3	52500	36000	1.03
60	UK 213	65	120	36	28	6.0	57500	40000	1.36



Standard Duty Spherical Outside Surface Ball Bearings Eccentric Locking Collar Type series SA 200

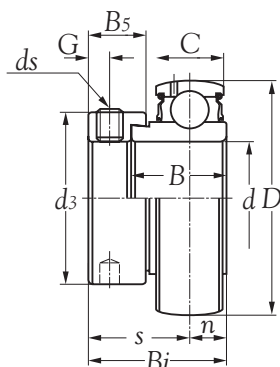

Shaft dia. mm inch	Bearing number	Nominal dimensions											Basic load ratings N		Mass kg	
		mm inch									ds	d3	B5	dynamic Cr		static Cor
		d	D	Bi	B	C	n	s	G							
12 1/2	SA 201 SA 201-8	12 0.5000	40 1.5748	28.5 1.1220	19.0 0.7480	12 0.4724	6.0 0.2362	22.5 0.8858	4.8 0.1890	M 6X1	28.6 1.1260	13.5 0.5315	9600	4600	0.14 0.14	
15 5/8	SA 202 SA 202-10	15 0.6250	40 1.5748	28.5 1.1220	19.0 0.7480	12 0.4724	6.0 0.2362	22.5 0.8858	4.8 0.1890	M 6X1	28.6 1.1260	13.5 0.5315	9600	4600	0.13 0.13	
17 11/16	SA 203 SA 203-11	17 0.6875	40 1.5748	28.5 1.1220	19.0 0.7480	12 0.4724	6.0 0.2362	22.5 0.8858	4.8 0.1890	M 6X1	28.6 1.1260	13.5 0.5315	9600	4600	0.12 0.12	
20 3/4	SA 204 SA 204-12	20 0.7500	47 1.8504	29.5 1.1614	20.0 0.7874	14 0.5512	7.0 0.2756	22.5 0.8858	4.8 0.1890	M 6X1	33.3 1.3110	13.5 0.5315	12800	6650	0.18 0.19	
25 1	SA 205 SA 205-16	25 1.0000	52 2.0472	30.5 1.2008	21.0 0.8268	15 0.5906	7.5 0.2953	23.0 0.9055	4.8 0.1890	M 6X1	38.1 1.5000	13.5 0.5315	14000	7850	0.20 0.18	
30 1-1/8 1-1/4	SA 206 SA 206-18 SA 206-20	30 1.1250 1.2500	62 2.4409	33.9 1.3346	22.0 0.8661	16 0.6299	8.0 0.3150	25.9 1.0197	6.0 0.2362	M 6X1	44.5 1.7520	15.9 0.6260	19500	11300	0.33 0.35 0.28	
35 1-1/4 1-3/8	SA 207 SA 207-20 SA 207-22	35 1.2500 1.3750	72 2.8346	37.5 1.4764	24.0 0.9449	18 0.6693	8.5 0.3346	29.0 1.1417	6.8 0.2677	M 8X1	55.6 2.1890	17.5 0.6890	25700	15300	0.50 0.56 0.51	
40 1-1/2	SA 208 SA 208-24	40 1.5000	80 3.1496	40.5 1.5945	27.0 1.0630	19 0.7480	9.5 0.3740	31.0 1.2205	6.8 0.2677	M 8X1	60.3 2.3740	18.3 0.7205	29100	17800	0.65 0.68	
45 1-5/8	SA 209 SA 209-26	45 1.6250	85 3.3465	42.2 1.6614	28.7 1.1299	20 0.7874	10.0 0.3937	32.2 1.2677	6.8 0.2677	M 8X1	63.5 2.5000	18.3 0.7205	32500	20400	0.69 0.82	
50 1-7/8	SA 210 SA 210-30	50 1.8750	90 3.5433	43.7 1.7205	30.2 1.1890	10.5 0.8268	21 0.4134	33.2 1.3071	6.8 0.2677	M 8X1	69.9 2.7520	18.3 0.7205	35000	23200	0.80 0.85	
55 2	SA 211 SA 211-32	55 2.0000	100 3.9370	48.4 1.9055	32.4 1.2756	23 0.9055	11.5 0.4528	36.9 1.4528	8.0 0.3150	M 10X1.25	76.2 3.0000	18.3 0.7205	43500	29200	0.87 1.18	

Standard Duty Spherical Outside Surface Ball Bearings Set Screws Type series SB 200

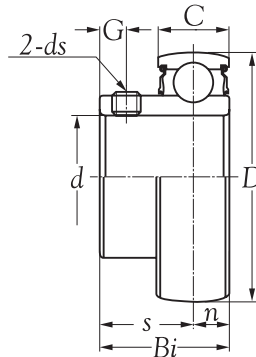

Shaft dia. mm inch	Bearing number	Nominal dimensions								Basic load ratings N		Mass kg
		d	D	Bi	C	mm		G	ds	dynamic Cr	static Cor	
						n	s					
12	SB 201	12	40	22	12	6.0	16.0	4.0	M 5X0.8	9600	4600	0.10
1/2	SB 201-8	0.5000	1.5748	0.8661	0.4724	0.2362	0.6299	0.1575				0.10
15	SB 202	15	40	22	12	6.0	16.0	4.0	M 5X0.8	9600	4600	0.09
5/8	SB 202-10	0.6250	1.5748	0.8661	0.4724	0.2362	0.6299	0.1575				0.09
17	SB 203	17	40	22	12	6.0	16.0	4.0	M 5X0.8	9600	4600	0.08
11/16	SB 203-11	0.6875	1.5748	0.8661	0.4724	0.2362	0.6299	0.1575				0.08
20	SB 204	20	47	25	14	7.0	18.0	5.0	M 6X0.75	12800	6650	0.13
3/4	SB 204-12	0.7500	1.8504	0.9843	0.5512	0.2756	0.7087	0.1969				0.15
25	SB 205	25	52	27	15	7.5	19.5	5.5	M 6X0.75	14000	7850	0.17
1	SB 205-16	1.0000	2.0472	1.0630	0.5906	0.2953	0.7677	0.2165				0.16
30	SB 206	30	62	29	16	8.0	21.0	6.0	M 6X0.75	19500	11300	0.26
1-1/8	SB 206-18	1.1250	2.4409	1.1417	0.6299	0.3150	0.8268	0.2362				0.27
1-1/4	SB 206-20	1.2500										0.24
35	SB 207	35	72	32	17	8.5	23.5	6.5	M 8X1	25700	15300	0.38
1-1/4	SB 207-20	1.2500	2.8346	1.2598	0.6693	0.3346	0.9252	0.2559				0.43
1-3/8	SB 207-22	1.3750										0.41
40	SB 208	40	80	34	19	9.5	24.5	7.0	M 8X1	29100	17800	0.50
1-1/2	SB 208-24	1.5000	3.1496	1.3386	0.7480	0.3740	0.9646	0.2756				0.54

Standard Duty Cylindrical Surface Ball Bearings Eccentric Locking Collar Type series CSA 200

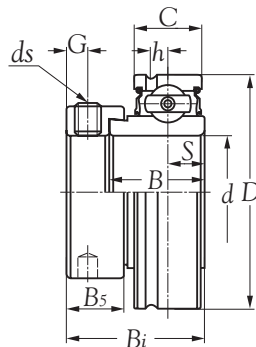

Shaft dia. mm inch	Bearing number	Nominal dimensions										Basic load ratings N		Mass kg	
		d	D	C	B	mm inch		h	B ₅	G	d _s	dynamic C _r	static C _{or}		
						B _i	S								
12 1/2	CSA 201	12	40	13	19.1	28.6	6.5	3.6	13.5	4.8	M 6X1	9550	4780	0.14	
	CSA 201-8	0.5000	1.5748	0.5118	0.7520	1.1260	0.2559	0.1417	0.5315	0.1890					0.14
15 5/8	CSA 202	15	40	13	19.1	28.6	6.5	3.6	13.5	4.8	M 6X1	9550	4780	0.13	
	CSA 202-10	0.6250	1.5748	0.5118	0.7520	1.1260	0.2559	0.1417	0.5315	0.1890					0.13
17 11/16	CSA 203	17	40	13	19.1	28.6	6.5	3.6	13.5	4.8	M 6X1	9550	4780	0.13	
	CSA 203-11	0.6875	1.5748	0.5118	0.7520	1.1260	0.2559	0.1417	0.5315	0.1890					0.13
20 3/4	CSA 204	20	47	14	21.4	30.9	7.5	4	13.5	4.8	M 6X1	12800	6650	0.15	
	CSA 204-12	0.7500	1.8504	0.5512	0.8425	1.2165	0.2953	0.1575	0.5315	0.1890					0.18
25 1	CSA 205	25	52	15	21.4	30.9	7.5	4.3	13.5	4.8	M 6X1	14000	7880	0.19	
	CSA 205-16	1.0000	2.0472	0.5906	0.8425	1.2165	0.2953	0.1693	0.5315	0.1890					0.18
30 1-1/8 1-1/4	CSA 206	30	62	16	23.8	35.7	9	5	15.9	6.0	M 6X1	19500	11200	0.33	
	CSA 206-18	1.1250	2.4409	0.6299	0.9370	1.4055	0.3543	0.1969	0.6260	0.2362					0.35
	CSA 206-20	1.2500													0.29
35 1-1/4 1-3/8	CSA 207	35	72	17	25.4	38.9	9.5	5.7	17.5	6.8	M 8X1	25700	15200	0.50	
	CSA 207-20	1.2500	2.8346	0.6693	1.0000	1.5315	0.3740	0.2244	0.6890	0.2677					0.52
	CSA 207-22	1.3750													0.51
40 1-1/2	CSA 208	40	80	18	30.2	43.6	11	6.2	18.3	6.8	M 8X1	29600	18200	0.65	
	CSA 208-24	1.5000	3.1496	0.7087	1.1890	1.7165	0.4331	0.2441	0.7205	0.2677					0.68
45 1-3/4	CSA 209	45	85	19	30.2	43.7	11	6.5	18.3	6.8	M 8X1	31850	20800	0.69	
	CSA 209-28	1.7500	3.3465	0.7480	1.1890	1.7205	0.4331	0.2677	0.7205	0.2677					0.69
50 1-7/8	CSA 210	50	90	20	30.2	43.6	11	6.5	18.3	6.8	M 8X1	35100	23200	0.79	
	CSA 210-30	1.8750	3.5433	0.7874	1.1890	1.7165	0.4331	0.2559	0.7205	0.2677					0.83
55 2	CSA 211	55	100	24	32.4	48.4	12	7.2	20.7	8.0	M 10X1.25	43550	29200	0.84	
	CSA 211-32	2.0000	3.9370	0.9449	1.2756	1.9055	0.4724	0.2835	0.8150	0.3150					0.96
60 2-1/4	CSA 212	60	110	24	33.4	49.3	12	8	22.3	8.4	M 10X1.25	47800	32800	1.20	
	CSA 212-36	2.2500	4.3307	0.9449	1.3150	1.9409	0.4724	0.3150	0.8780	0.3307					1.30

Standard Duty Cylindrical Surface Ball Bearings Eccentric Locking Collar Type series CSB 200

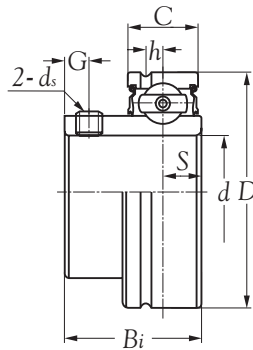

Shaft dia. mm inch	Bearing number	Nominal dimensions								Basic load ratings N		Mass kg
		d	D	C	mm inch		S	G	ds	dynamic Cr	static Cor	
					h	Bi						
12	CSB 201	12	40	12	3.6	22	6	4	M5x0.8	9550	4780	0.90
1/2	CSB 201-8	0.5000	1.5748	0.4724	0.1417	0.8661	0.2362	0.1575	10#-32UNF			
15	CSB 202	15	40	12	3.6	22	6	4	M5x0.8	9550	4780	0.80
5/8	CSB 202-10	0.6250	1.5748	0.4724	0.1417	0.8661	0.2362	0.1575	10#-32UNF			
17	CSB 203	17	40	12	3.6	22	6	4	M5x0.8	9550	4780	0.10
11/16	CSB 203-11	0.6875	1.5748	0.4724	0.1417	0.8661	0.2362	0.1575	10#-32UNF			
20	CSB 204	20	47	14	4	25	7	5	M6x1	12800	6650	0.13
3/4	CSB 204-12	0.7500	1.8504	0.5512	0.1575	0.9843	0.2756	0.1969	1/4-28UNF			
25	CSB 205	25	52	15	4.3	27	7.5	5.5	M6x1	14000	7880	0.17
1	CSB 205-16	1.0000	2.0472	0.5906	0.1693	1.0630	0.2953	0.2165	1/4-28UNF			
30	CSB 206	30	62	16	5	29	8	6	M6x1	19500	11200	0.27
1-1/8	CSB 206-18	1.1250	2.4409	0.6299	0.1969	1.1417	0.3150	0.2362	1/4-28UNF			
1-1/4	CSB 206-20	1.2500										
35	CSB 207	35	72	18	5.7	32	9	6	M6x1	25700	15200	0.38
1-1/4	CSB 207-20	1.2500	2.8346	0.7087	0.2244	1.2598	0.3543	0.2362	1/4-28UNF			
1-3/8	CSB 207-22	1.3750										
40	CSB 208	40	80	19	6.2	34	9.5	7	M8x1	29600	18200	0.50
1-1/2	CSB 208-24	1.5000	3.1496	0.7480	0.2441	1.3386	0.3740	0.2756	5/16-24UNF			

Standard Duty Cylindrical Surface Ball Bearings Eccentric Locking Collar Type series SER 200

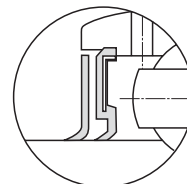
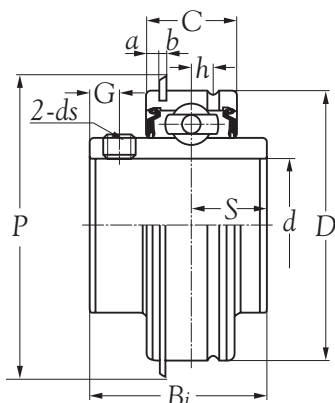

Dual seals

Shaft dia. mm inch	Bearing number	Nominal dimensions											Basic load ratings		Mass kg
		mm inch											N dynamic Cr	static Cor	
		d	D	Bi	C	S	a	b	p	G	h	ds			
15 5/8	SER 202 SER 202-10	15 0.6250	47 1.8504	31 1.2205	15.9 0.6260	12.7 0.5000	2.38 0.0937	1.07 0.0421	52.7 2.0748	4.7 0.1850	4.4 0.1732	M6x1 1/4-28UNF	12800	6650	0.17
17 11/16	SER 203 SER 203-11	17 0.6875	47 1.8504	31 1.2205	15.9 0.6260	12.7 0.5000	2.38 0.0937	1.07 0.0421	52.7 2.0748	4.7 0.1850	4.4 0.1732	M6x1 1/4-28UNF	12800	6650	0.17
20 3/4	SER 204 SER 204-12	20 0.7500	47 1.8504	31 1.2205	15.9 0.626	12.7 0.5	2.38 0.0937	1.07 0.0421	52.7 2.0748	4.7 0.1850	4.4 0.1732	M6x1 1/4-28UNF	12800	6650	0.24
25 15/16	SER 205 SER 205-16	25 1.0000	52 2.0472	34 1.3386	19 0.7480	14.3 0.5630	2.38 0.0937	1.07 0.0421	57.9 2.2795	5.5 0.2165	4.5 0.1772	M6x1 1/4-28UNF	14000	7880	0.27
30 1-1/8 1-1/4	SER 206 SER 206-18 SER 206-20	30 1.1250 1.2500	62 2.4409	38.1 1.5000	22.2 0.8740	15.9 0.6260	3.18 0.1252	1.65 0.0650	67.7 2.6654	5.5 0.2165	5.3 0.2087	M6x1 1/4-28UNF	19500	11200	0.39
35 1-1/4 1-3/8	SER 207 SER 207-20 SER 207-22	35 1.2500 1.3750	72 2.8346	42.9 1.6890	23.8 0.9370	17.5 0.6890	3.18 0.1252	1.65 0.0650	78.6 3.0945	6.5 0.2559	5.8 0.2283	M8x1 5/16-24UNF	25700	15200	0.61
40 1-9/16	SER 208 SER 208-26	40 1.5625	80 3.1496	49.2 1.9370	27.8 1.0945	19 0.7480	3.18 0.1252	1.65 0.0650	86.6 3.4094	8 0.3150	6.3 0.2480	M8x1 5/16-24UNF	29600	18200	0.81
45 1-3/4	SER 209 SER 209-28	45 1.7500	85 3.3465	49.2 1.9370	27.8 1.0945	19 0.7480	3.18 0.1252	1.65 0.0650	91.6 3.6063	8 0.3150	7.5 0.2953	M8x1 5/16-24UNF	31850	20800	0.90
50 1-7/8	SER 210 SER 210-30	50 1.8750	90 3.5433	51.6 2.0315	28.6 1.1260	19 0.7480	3.18 0.1252	2.41 0.0949	96.5 3.7992	9 0.3543	6.8 0.2677	M10x1.25 3/8-24UNF	35100	23200	0.96
55 2	SER 211 SER 211-32	55 2.0000	100 3.9370	55.6 2.1890	30.2 1.1890	22.2 0.8740	3.18 0.1252	2.41 0.0949	106.5 4.1929	9 0.3543	7.6 0.2992	M10x1.25 3/8-24UNF	43550	29200	1.41
60 2-1/4	SER 212 SER 212-36	60 2.2500	110 4.3307	65.1 2.5630	31.8 1.2520	25.4 1.0000	3.18 0.1252	2.41 0.0949	116.6 4.5906	10.5 0.4134	8.4 0.3307	M10x1.25 3/8-24UNF	47800	32800	1.95

KSM[®] NOTE

A series of horizontal dashed lines for writing notes.





[Http://www.minamiguchi.co.jp](http://www.minamiguchi.co.jp)

南口精工株式会社

