

SPHERICAL ROLLER BEARINGS and SPHERICAL ROLLER THRUST BEARINGS



SPHERICAL ROLLER BEARINGS	1
Tolerance Values	4
Internal Clearance	9
Dimension Tables	10
SPHERICAL ROLLER THRUST BEARINGS	29
Tolerance Values	29
Dimension Tables	30



Spherical Roller Bearings

Design and configuration

Spherical Roller Bearings are particularly suitable for applications where misalignment can arise from error in mounting or from shaft deflection.

NACHI Spherical Roller Bearings are manufactured in a number of design and material configurations depending on the type of application and size of the bearing.

See the table below for the roller, guide ring and cage design for NACHI Spherical Roller Bearings. They can sustain radial and axial loads.

Attention

(1) For high axial load applications, the axial load F_a must not exceed 0.6 of the radial load F_r . If the axial load exceeds 0.6 F_r , please contact NACHI engineers for design assistance.

(2) For applications where oscillating loads (such as shaker screen applications) or high speed is involved, please contact NACHI for design assistance.

(3) In very lightly loaded or no load conditions, sliding motion can occur which could damage the bearing.

To prevent this damage, bearings must be subjected to a load greater than 0.02 C_r (basic dynamic load rating).

(4) The material coefficient number of the bearing is taken into consideration for the dynamic load rating.

* This only applies to spherical roller bearing.

Design and configurations

Series	Type	EX	EX1	E	E2	E	AEX	AX	A2X	AX		
239						20,26, 44 ~ /1060		28 ~ 40				
230				20 ~ 36		38 ~ /1000		20 ~ 36	38 ~ 48			
240			24 ~ 36			38 ~ /600, /670,/800				24 ~ 36		
231			20 ~ 34			36 ~ /800		20 ~ 34	36 ~ 48			
241			22 ~ 32			36 ~ /500				22 ~ 34		
222		05 ~ 30		32	32	34 ~ 68	05 ~ 30		32			
232			18,20~30	16,17,19		32 ~ /600		20 ~ 30	32 ~ 40			
213			11 ~ 22	04~10,24				06 ~ 22				
223		08 ~ 26				28 ~ 60	07 ~ 26		28, 30			
Cross section												
	Roller	Symmetric			Symmetric			Nonsymmetric			Nonsymmetric	
	Center guide	Floating ring			Inner ring rib			Inner ring rib			Inner ring rib	
	Cage	Pressed steel			Machined high strength brass			Machined high strength brass			Pressed high strength brass	

Spherical Roller Bearings

Lubrication holes and groove

The outer ring of Spherical Roller Bearings are often made with lubrication holes and a groove for feeding lubricant. The outer ring may also be configured with oil holes only depending on fitting, mounting or service conditions.

Heat-stabilized bearings

NACHI Spherical Roller Bearings are subjected to a heat-stabilization treatment as standard. They can be used at operating temperature of up to 200°C with minimal dimensional changes occurring.

Lubrication holes and groove

Modification to outer ring	Suffix	Part No. Example
Lubrication holes and groove	W33	22330E W33
Lubrication holes	W20	22330E W20

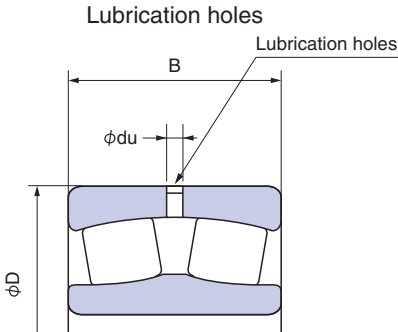
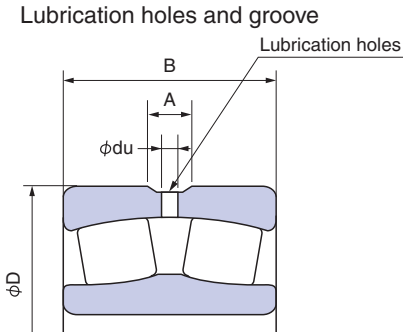

Misalignment

Maximum permissible misalignment angle is about 2° under general service conditions.

But its angle will vary with the series, service condition and surrounding structure.

As rotational speed increases, misaligned bearings will tend to generate more noise.

Due to noise constraints, the practical maximum misalignment in a bearing may be considerably less than the maximum permissible misalignment.

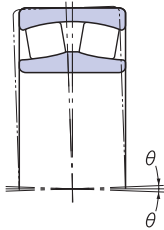

Mounting bearings with tapered bore

Mounting bearings with a tapered bore requires some experience and technique.

Bearings with tapered bore are always mounted with an interference fit on the shaft.

To measure the amount of interference fit on the shaft, the axial displacement of the inner ring or the reduction of radial internal clearance due to the interference fit can be used. Generally, the measurement of reduction in radial internal clearance is a more reliable method than measurement of the axial displacement of the inner ring.

Unit: mm

Nominal bore diameter d		Radial clearance reduction		Axial displacement ⁽¹⁾				Internal clearance after mounting ⁽²⁾		
				1 : 12	Taper	1 : 30		Min		
Over	Incl.	Min	Max	Min	Max	Min	Max	Normal	C3	C4
24	30	0.015	0.020	0.3	0.35	—	—	0.015	0.020	0.035
30	40	0.020	0.025	0.35	0.4	—	—	0.015	0.025	0.040
40	50	0.025	0.030	0.34	0.45	—	—	0.020	0.030	0.050
50	65	0.030	0.040	0.45	0.6	—	—	0.025	0.035	0.055
65	80	0.040	0.050	0.6	0.75	—	—	0.025	0.040	0.070
80	100	0.045	0.060	0.7	0.9	1.7	2.2	0.035	0.050	0.080
100	120	0.050	0.070	0.75	1.1	1.9	2.7	0.050	0.065	0.100
120	140	0.065	0.090	1.1	1.4	2.7	3.5	0.055	0.080	0.110
140	160	0.075	0.100	1.2	1.6	3.0	4.0	0.055	0.090	0.130
160	180	0.080	0.110	1.3	1.7	3.2	4.2	0.060	0.100	0.150
180	200	0.090	0.130	1.4	2.0	3.5	5.0	0.070	0.100	0.160
200	225	0.100	0.140	1.6	2.2	4.0	5.5	0.080	0.120	0.180
225	250	0.110	0.150	1.7	2.4	4.2	6.0	0.090	0.130	0.200
250	280	0.120	0.170	1.9	2.7	4.7	6.7	0.100	0.140	0.220
280	315	0.130	0.190	2.0	3.0	5.0	7.5	0.110	0.150	0.240
315	355	0.150	0.210	2.4	3.3	6.0	8.2	0.120	0.170	0.260
355	400	0.170	0.230	2.6	3.6	6.5	9.0	0.130	0.190	0.290
400	450	0.200	0.260	3.1	4.0	7.7	10	0.130	0.200	0.310
450	500	0.210	0.280	3.3	4.4	8.2	11	0.160	0.230	0.350
500	560	0.240	0.320	3.7	5.0	9.2	12.5	0.170	0.250	0.360
560	630	0.260	0.350	4.0	5.4	10	13.5	0.200	0.290	0.410
630	710	0.300	0.400	4.6	6.2	11.5	15.5	0.210	0.310	0.450
710	800	0.340	0.450	5.3	7.0	13.3	17.5	0.230	0.350	0.510
800	900	0.370	0.500	5.7	7.8	14.3	19.5	0.270	0.390	0.570
900	1000	0.410	0.550	6.3	8.5	15.8	21	0.300	0.430	0.640
1000	1120	0.450	0.600	6.8	9.0	17	23	0.320	0.480	0.700
1120	1250	0.490	0.650	7.4	9.8	18.5	25	0.340	0.540	0.770

Note: (1) The values are applied for mounting on solid shaft. In case of hollow shaft, larger axial displacement should be applied.

(2) In following cases, please make sure radial internal clearance after mounting.

- Initial radial clearance is in the lower half of the tolerance range.

- Large temperature difference exists between inner ring and outer ring in operation.

Internal clearance after mounting must be equal to or over these values.

Tolerance Values for Radial Bearings

Tolerance Values of Inner Ring and of Outer Ring Width

Nominal bearing bore diameter d (mm)		Single plane mean bore diameter deviation (2) Δd_{mp}								Bearing with	
		Class 0		Class 6		Class 5		Class 4		Deviation of a single bore diameter (2) Δd_s	
										Class 4	
		Over	Incl.	High	Low	High	Low	High	Low	High	Low
0.6 ⁽¹⁾	2.5	0	-8	0	-7	0	-5	0	-4	0	-4
2.5	10	0	-8	0	-7	0	-5	0	-4	0	-4
10	18	0	-8	0	-7	0	-5	0	-4	0	-4
18	30	0	-10	0	-8	0	-6	0	-5	0	-5
30	50	0	-12	0	-10	0	-8	0	-6	0	-6
50	80	0	-15	0	-12	0	-9	0	-7	0	-7
80	120	0	-20	0	-15	0	-10	0	-8	0	-8
120	150	0	-25	0	-18	0	-13	0	-10	0	-10
150	180	0	-25	0	-18	0	-13	0	-10	0	-10
180	250	0	-30	0	-22	0	-15	0	-12	0	-12
250	315	0	-35	0	-25	0	-18	-	-	-	-
315	400	0	-40	0	-30	0	-23	-	-	-	-
400	500	0	-45	0	-35	-	-	-	-	-	-
500	630	0	-50	0	-40	-	-	-	-	-	-
630	800	0	-75	-	-	-	-	-	-	-	-
800	1000	0	-100	-	-	-	-	-	-	-	-
1000	1250	0	-125	-	-	-	-	-	-	-	-
1250	1600	0	-160	-	-	-	-	-	-	-	-
1600	2000	0	-200	-	-	-	-	-	-	-	-

Nominal bearing bore diameter d (mm)		Deviation of a single inner ring width (or a single outer ring width) (3) ΔB_s (or ΔC_s)								Inner (or outer) ring width variation V_{Bs} (or V_{Cs})			
		Single bearing				Combination bearing (4)				Inner ring (or outer ring) (3)		Inner ring	
		Class 0		Class 5		Class 0		Class 5		Class 0	Class 6	Class 5	Class 4
		Over	Incl.	High	Low	High	Low	High	Low	High	Low	Max	Max
0.6 ⁽¹⁾	2.5	0	-40	0	-40	-	-	0	-250	12	12	5	2.5
2.5	10	0	-120	0	-40	0	-250	0	-250	15	15	5	2.5
10	18	0	-120	0	-80	0	-250	0	-250	20	20	5	2.5
18	30	0	-120	0	-120	0	-250	0	-250	20	20	5	2.5
30	50	0	-120	0	-120	0	-250	0	-250	20	20	5	3
50	80	0	-150	0	-150	0	-380	0	-250	25	25	6	4
80	120	0	-200	0	-200	0	-380	0	-380	25	25	7	4
120	150	0	-250	0	-250	0	-500	0	-380	30	30	8	5
150	180	0	-250	0	-250	0	-500	0	-380	30	30	8	5
180	250	0	-300	0	-300	0	-500	0	-500	30	30	10	6
250	315	0	-350	0	-350	0	-500	0	-500	35	35	13	-
315	400	0	-400	0	-400	0	-630	0	-630	40	40	15	-
400	500	0	-450	-	-	-	-	-	-	50	45	-	-
500	630	0	-500	-	-	-	-	-	-	60	50	-	-
630	800	0	-750	-	-	-	-	-	-	70	-	-	-
800	1000	0	-1000	-	-	-	-	-	-	80	-	-	-
1000	1250	0	-1250	-	-	-	-	-	-	100	-	-	-
1250	1600	0	-1600	-	-	-	-	-	-	120	-	-	-
1600	2000	0	-2000	-	-	-	-	-	-	140	-	-	-

- Notes: (1) This diameter is included in this group.
(2) Applicable to bearings with cylindrical bore.
(3) Width deviation and variation of outer ring are the same with of inner ring. Outer ring width variation of classes 5 and 4 are listed on page 7.
(4) Applicable to the rings of single bearings made for combination bearing.
(5) Applicable to radial ball bearings such as deep groove ball bearings or angular contact ball bearings.
- Remarks: The high deviation of bearing cylindrical bore diameter specified in this table does not apply within a distance of $1.2 \times r$ (max) from the ring face.

Unit: μm

cylindrical bore

Bore diameter variation in a single radial plane (2) V_{dp}										Mean bore diameter variation (2) V_{dmp}				Nominal bearing bore diameter d (mm)	
Class 0			Class 6			Class 5		Class 4		Class 0	Class 6	Class 5	Class 4		
Diameter series			Diameter series			Diameter series		Diameter series							
7,8,9	0,1	2,3,4	7,8,9	0,1	2,3,4	7,8,9	0,1,2,3,4	7,8,9	0,1,2,3,4	Max	Max	Max	Max		
Max			Max			Max		Max		Max	Max	Max	Max		
10	8	6	9	7	5	5	4	4	3	6	5	3	2	0.6 ⁽¹⁾	2.5
10	8	6	9	7	5	5	4	4	3	6	5	3	2	2.5	10
10	8	6	9	7	5	5	4	4	3	6	5	3	2	10	18
13	10	8	10	8	6	6	5	5	4	8	6	3	2.5	18	30
15	12	9	13	10	8	8	6	6	5	9	8	4	3	30	50
19	19	11	15	15	9	9	7	7	5	11	9	5	3.5	50	80
25	25	15	19	19	11	10	8	8	6	15	11	5	4	80	120
31	31	19	23	23	14	13	10	10	8	19	14	7	5	120	150
31	31	19	23	23	14	13	10	10	8	19	14	7	5	150	180
38	38	23	28	28	17	15	12	12	9	23	17	8	6	180	250
44	44	26	31	31	19	18	14	—	—	26	19	9	—	250	315
50	50	30	38	38	23	23	18	—	—	30	23	12	—	315	400
56	56	34	44	44	26	—	—	—	—	34	26	—	—	400	500
63	63	38	50	50	30	—	—	—	—	38	30	—	—	500	630
—	—	—	—	—	—	—	—	—	—	—	—	—	—	630	800
—	—	—	—	—	—	—	—	—	—	—	—	—	—	800	1000
—	—	—	—	—	—	—	—	—	—	—	—	—	—	1000	1250
—	—	—	—	—	—	—	—	—	—	—	—	—	—	1250	1600
—	—	—	—	—	—	—	—	—	—	—	—	—	—	1600	2000

Unit: μm

Radial runout of assembled bearing inner ring K_{ia}				Inner ring reference face runout with bore S_{di}		Assembled bearing inner ring face runout with raceway S_{ia} (5)		Nominal bearing bore diameter d (mm)	
Class 0	Class 6	Class 5	Class 4	Class 5	Class 4	Class 5	Class 4		
Max	Max	Max	Max	Max	Max	Max	Max		
10	5	4	2.5	7	3	7	3	0.6 ⁽¹⁾	2.5
10	6	4	2.5	7	3	7	3	2.5	10
10	7	4	2.5	7	3	7	3	10	18
13	8	4	3	8	4	8	4	18	30
15	10	5	4	8	4	8	4	30	50
20	10	5	4	8	5	8	5	50	80
25	13	6	5	9	5	9	5	80	120
30	18	8	6	10	6	10	7	120	150
30	18	8	6	10	6	10	7	150	180
40	20	10	8	11	7	13	8	180	250
50	25	13	—	13	—	15	—	250	315
60	30	15	—	15	—	20	—	315	400
65	35	—	—	—	—	—	—	400	500
70	40	—	—	—	—	—	—	500	630
80	—	—	—	—	—	—	—	630	800
90	—	—	—	—	—	—	—	800	1000
100	—	—	—	—	—	—	—	1000	1250
120	—	—	—	—	—	—	—	1250	1600
140	—	—	—	—	—	—	—	1600	2000

Tolerance Values for Radial Bearings

Tolerance Values of Outer Ring

Nominal bearing outside diameter D (mm)		Single plane mean outside diameter deviation ΔD_{mp}								Bearing	
		Class 0		Class 6		Class 5		Class 4		Deviation of a single outside diameter ΔD_s	
										Class 4	
		Over	Incl.	High	Low	High	Low	High	Low	High	Low
2.5 ⁽¹⁾	6	0	-8	0	-7	0	-5	0	-4	0	-4
6	18	0	-8	0	-7	0	-5	0	-4	0	-4
18	30	0	-9	0	-8	0	-6	0	-5	0	-5
30	50	0	-11	0	-9	0	-7	0	-6	0	-6
50	80	0	-13	0	-11	0	-9	0	-7	0	-7
80	120	0	-15	0	-13	0	-10	0	-8	0	-8
120	150	0	-18	0	-15	0	-11	0	-9	0	-9
150	180	0	-25	0	-18	0	-13	0	-10	0	-10
180	250	0	-30	0	-20	0	-15	0	-11	0	-11
250	315	0	-35	0	-25	0	-18	0	-13	0	-13
315	400	0	-40	0	-28	0	-20	0	-15	0	-15
400	500	0	-45	0	-33	0	-23	—	—	—	—
500	630	0	-50	0	-38	0	-28	—	—	—	—
630	800	0	-75	0	-45	0	-35	—	—	—	—
800	1000	0	-100	0	-60	—	—	—	—	—	—
1000	1250	0	-125	—	—	—	—	—	—	—	—
1250	1600	0	-160	—	—	—	—	—	—	—	—
1600	2000	0	-200	—	—	—	—	—	—	—	—
2000	2500	0	-250	—	—	—	—	—	—	—	—

Nominal bearing outside diameter D (mm)		Bearing outside diameter				Radial runout of assembled bearing outer ring			
		Mean outside diameter variation (2) V_{Dmp}				K_{ea}			
		Class 0	Class 6	Class 5	Class 4	Class 0	Class 6	Class 5	Class 4
Over	Incl.	Max	Max	Max	Max	Max	Max	Max	Max
2.5 ⁽¹⁾	6	6	5	3	2	15	8	5	3
6	18	6	5	3	2	15	8	5	3
18	30	7	6	3	2.5	15	9	6	4
30	50	8	7	4	3	20	10	7	5
50	80	10	8	5	3.5	25	13	8	5
80	120	11	10	5	4	35	18	10	6
120	150	14	11	6	5	40	20	11	7
150	180	19	14	7	5	45	23	13	8
180	250	23	15	8	6	50	25	15	10
250	315	26	19	9	7	60	30	18	11
315	400	30	21	10	8	70	35	20	13
400	500	34	25	12	—	80	40	23	—
500	630	38	29	14	—	100	50	25	—
630	800	55	34	18	—	120	60	30	—
800	1000	75	45	—	—	140	75	—	—
1000	1250	—	—	—	—	160	—	—	—
1250	1600	—	—	—	—	190	—	—	—
1600	2000	—	—	—	—	220	—	—	—
2000	2500	—	—	—	—	250	—	—	—

- Notes: (1) This diameter is included in this group.
(2) Applicable without internal or external snap ring.
(3) Applicable to radial ball bearings such as deep groove ball bearings or angular contact ball bearings.
(4) Outer ring width variation of class 0 and 6 are listed on page 4.

Remarks: The low deviation of bearing outside diameter specified in this table does not apply within a distance of $1.2 \times r$ (max) from the ring face.

Unit: μm

outside diameter

Outside diameter variation in a single radial plane (2)												Nominal bearing outside diameter D (mm)	
Class 0				Class 6				Class 5		Class 4			
Open bearing			Seal - shield bearing	Open bearing			Seal - shield bearing	Open bearing		Open bearing			
Diameter series			2,3,4	Diameter series			0,1,2,3,4	Diameter series		Diameter series			
7,8,9	0,1	2,3,4	2,3,4	7,8,9	0,1	2,3,4	0,1,2,3,4	7,8,9	0,1,2,3,4	7,8,9	0,1,2,3,4	Over	Incl.
Max	Max	Max	Max	Max	Max	Max	Max	Max	Max	Max	Max		
10	8	6	10	9	7	5	9	5	4	4	3	2.5(1)	6
10	8	6	10	9	7	5	9	5	4	4	3	6	18
12	9	7	12	10	8	6	10	6	5	5	4	18	30
14	11	8	16	11	9	7	13	7	5	6	5	30	50
16	13	10	20	14	11	8	16	9	7	7	5	50	80
19	19	11	26	16	16	10	20	10	8	8	6	80	120
23	23	14	30	19	19	11	25	11	8	9	7	120	150
31	31	19	38	23	23	14	30	13	10	10	8	150	180
38	38	23	—	25	25	15	—	15	11	11	8	180	250
44	44	26	—	31	31	19	—	18	14	13	10	250	315
50	50	30	—	35	35	21	—	20	15	15	11	315	400
56	56	34	—	41	41	25	—	23	17	—	—	400	500
63	63	38	—	48	48	29	—	28	21	—	—	500	630
94	94	55	—	56	56	34	—	35	26	—	—	630	800
125	125	75	—	75	75	45	—	—	—	—	—	800	1000
—	—	—	—	—	—	—	—	—	—	—	—	1000	1250
—	—	—	—	—	—	—	—	—	—	—	—	1250	1600
—	—	—	—	—	—	—	—	—	—	—	—	1600	2000
—	—	—	—	—	—	—	—	—	—	—	—	2000	2500

Unit: μm

Variation of bearing outside surface generatrix inclination with outer ring reference face S_D		Assembled bearing outer ring face runout with raceway S_{ea} (3)		Outer ring width variation V_{Cs}		Nominal bearing outside diameter D (mm)	
Class 5	Class 4	Class 5	Class 4	Class 5	Class 4		
Max	Max	Max	Max	Max	Max		
8	4	8	5	2.5	2.5	2.5(1)	6
8	4	8	5	2.5	2.5	6	18
8	4	8	5	2.5	2.5	18	30
8	4	8	5	2.5	2.5	30	50
8	4	10	6	3	3	50	80
9	5	11	8	4	4	80	120
10	5	13	8	5	5	120	150
10	5	14	8	5	5	150	180
11	7	15	10	7	7	180	250
13	8	18	11	7	7	250	315
13	10	20	13	8	8	315	400
15	—	23	15	—	—	400	500
18	—	25	18	—	—	500	630
20	—	30	20	—	—	630	800
—	—	—	—	—	—	800	1000
—	—	—	—	—	—	1000	1250
—	—	—	—	—	—	1250	1600
—	—	—	—	—	—	1600	2000
—	—	—	—	—	—	2000	2500

Tolerances for Tapered Bores

Tolerances for Tapered Bores

d : Nominal bearing bore diameter

d₁ : Basic diameter at the theoretical large end of a tapered bore

in case of 1/12 taper $d_1 = d + \frac{1}{12} B$

in case of 1/30 taper $d_1 = d + \frac{1}{30} B$

Δd_{mp} : Mean bore diameter deviation at theoretical small end of a tapered bore

Δd_{1mp} : Mean bore diameter deviation at theoretical large end of a tapered bore

B : Nominal bearing inner ring width

α : Nominal taper angle (half of cone angle)

in case of 1/12 taper $\alpha = 2^\circ 23' 9.4''$
 $= 2.38594^\circ$
 $= 0.041643 \text{ rad}$

in case of 1/30 taper $\alpha = 0^\circ 57' 17.4''$
 $= 0.95484^\circ$
 $= 0.016665 \text{ rad}$

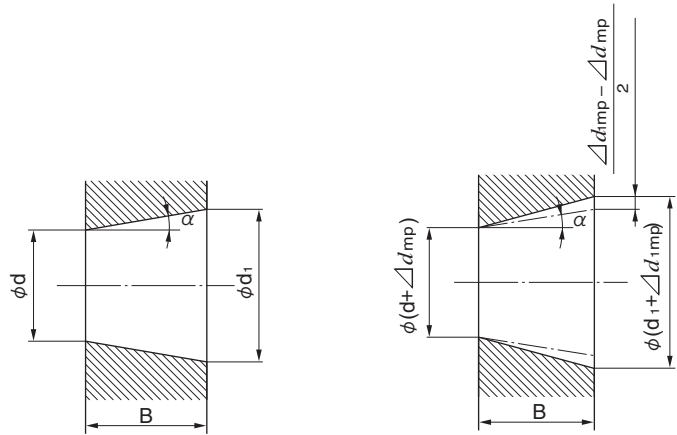

Theoretical tapered bore

Tapered bore with actual mean diameters at their deviations

1/12 Tapered Bore (Class 0)

Unit: μm

Nominal bearing bore dimension d (mm)		Mean bore diameter deviation at theoretical small end of a tapered bore		Bore diameter variation in a single radial plane (1)(2)		V _{dP}
		Δd_{mp}		$\Delta d_{1mp} - \Delta d_{mp}$		
Over	Incl.	High	Low	High	Low	Max
	10	+22	0	+15	0	9
	18	+27	0	+18	0	11
	30	+33	0	+21	0	13
	50	+39	0	+25	0	16
	80	+46	0	+30	0	19
	120	+54	0	+35	0	22
	180	+63	0	+40	0	40
	250	+72	0	+46	0	46
	315	+81	0	+52	0	52
	400	+89	0	+57	0	57
	500	+97	0	+63	0	63
	630	+110	0	+70	0	70
	800	+125	0	+80	0	—
	1000	+140	0	+90	0	—
	1250	+165	0	+105	0	—
	1600	+195	0	+125	0	—

Note: (1) Applicable to all radial planes of tapered bore.

(2) Not applicable to bearings of diameter series 7 and 8.

1/30 Tapered Bore (Class 0)

Unit: μm

Nominal bearing bore dimension d (mm)		Mean bore diameter deviation at theoretical small end of a tapered bore		Bore diameter variation in a single radial plane (1)(2)		V _{dP}
		Δd_{mp}		$\Delta d_{1mp} - \Delta d_{mp}$		
Over	Incl.	High	Low	High	Low	Max
	50	+15	0	+30	0	19
	80	+20	0	+35	0	22
	120	+25	0	+40	0	40
	180	+30	0	+46	0	46
	250	+35	0	+52	0	52
	315	+40	0	+57	0	57
	400	+45	0	+63	0	63
	500	+50	0	+70	0	70

Note: (1) Applicable to all radial planes of tapered bore.

(2) Not applicable to bearings of diameter series 7 and 8.

Internal Clearance

Radial Internal Clearance of Spherical Roller Bearings with Cylindrical Bore (ISO)

 Unit: μm

Nominal bearing bore diameter d(mm)		Radial clearance									
		C2		CN(Normal)		C3		C4		C5	
Over	Incl.	Min	Max	Min	Max	Min	Max	Min	Max	Min	Max
14	18	10	20	20	35	35	45	45	60	60	75
18	24	10	20	20	35	35	45	45	60	60	75
24	30	15	25	25	40	40	55	55	75	75	95
30	40	15	30	30	45	45	60	60	80	80	100
40	50	20	35	35	55	55	75	75	100	100	125
50	65	20	40	40	65	65	90	90	120	120	150
65	80	30	50	50	80	80	110	110	145	145	180
80	100	35	60	60	100	100	135	135	180	180	225
100	120	40	75	75	120	120	160	160	210	210	260
120	140	50	95	95	145	145	190	190	240	240	300
140	160	60	110	110	170	170	220	220	280	280	350
160	180	65	120	120	180	180	240	240	310	310	390
180	200	70	130	130	200	200	260	260	340	340	430
200	225	80	140	140	220	220	290	290	380	380	470
225	250	90	150	150	240	240	320	320	420	420	520
250	280	100	170	170	260	260	350	350	460	460	570
280	315	110	190	190	280	280	370	370	500	500	630
315	355	120	200	200	310	310	410	410	550	550	690
355	400	130	220	220	340	340	450	450	600	600	750
400	450	140	240	240	370	370	500	500	660	660	820
450	500	140	260	260	410	410	550	550	720	720	900
500	560	150	280	280	440	440	600	600	780	780	1000
560	630	170	310	310	480	480	650	650	850	850	1100
630	710	190	350	350	530	530	700	700	920	920	1190
710	800	210	390	390	580	580	770	770	1010	1010	1300
800	900	230	430	430	650	650	860	860	1120	1120	1440
900	1000	260	480	480	710	710	930	930	1220	1220	1570

Radial Internal Clearance of Spherical Roller Bearings with Tapered Bore (ISO)

 Unit: μm

Nominal bearing bore diameter d(mm)		Radial clearance									
		C2		CN(Normal)		C3		C4		C5	
Over	Incl.	Min	Max	Min	Max	Min	Max	Min	Max	Min	Max
18	24	15	25	25	35	35	45	45	60	60	75
24	30	20	30	30	40	40	55	55	75	75	95
30	40	25	35	35	50	50	65	65	85	85	105
40	50	30	45	45	60	60	80	80	100	100	130
50	65	40	55	55	75	75	95	95	120	120	160
65	80	50	70	70	95	95	120	120	150	150	200
80	100	55	80	80	110	110	140	140	180	180	230
100	120	65	100	100	135	135	170	170	220	220	280
120	140	80	120	120	160	160	200	200	260	260	330
140	160	90	130	130	180	180	230	230	300	300	380
160	180	100	140	140	200	200	260	260	340	340	430
180	200	110	160	160	220	220	290	290	370	370	470
200	225	120	180	180	250	250	320	320	410	410	520
225	250	140	200	200	270	270	350	350	450	450	570
250	280	150	220	220	300	300	390	390	490	490	620
280	315	170	240	240	330	330	430	430	540	540	680
315	355	190	270	270	360	360	470	470	590	590	740
355	400	210	300	300	400	400	520	520	650	650	820
400	450	230	330	330	440	440	570	570	720	720	910
450	500	260	370	370	490	490	630	630	790	790	1000
500	560	290	410	410	540	540	680	680	870	870	1100
560	630	320	460	460	600	600	760	760	980	980	1230
630	710	350	510	510	670	670	850	850	1090	1090	1360
710	800	390	570	570	750	750	960	960	1220	1220	1500
800	900	440	640	640	840	840	1070	1070	1370	1370	1690
900	1000	490	710	710	930	930	1190	1190	1520	1520	1860

Spherical Roller Bearings

Bore Diameter : 20 ~ 60mm

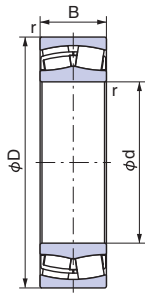

Cylindrical bore

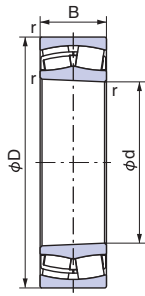

Tapered bore

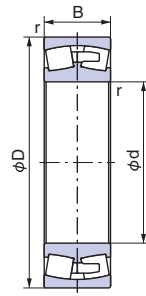

With machined brass cage

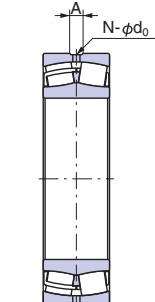

With oil holes / oil groove (W33)

1N=0.102kgf

Boundary dimensions (mm)				Bearing No.		Basic dynamic load rating Cr (N)	Basic static load rating Cor (N)	Limiting speed (min ⁻¹)	
d	D	B	r (min)	Cylindrical bore	Tapered bore			Grease lubrication	Oil lubrication
20	52	15	1.1	21304E	21304EK	47000	33500	11000	14000
	52	18	1	22205EX	22205EXK	63000	48000	10500	13000
25	52	18	1	22205AEX	22205AEXK	48500	34500	13300	16500
	62	17	1.1	21305E	21305EK	64000	47500	9000	11500
30	62	20	1	22206EX	22206EXK	84500	65000	8500	11000
	62	20	1	22206AEX	22206AEXK	68000	48500	11200	14400
	72	19	1.1	21306E	21306EK	83000	62500	8000	9500
	72	19	1.1	21306AX	21306AXK	73000	50900	9700	12700
	72	23	1.1	22207EX	22207EXK	112000	88500	7500	9500
	72	23	1.1	22207AEX	22207AEXK	94500	70000	9600	12400
35	80	21	1.5	21307E	21307EK	96000	76000	7000	8500
	80	21	1.5	21307AX	21307AXK	89000	63100	9000	11200
	80	31	1.5	22307AEX	22307AEXK	145000	107000	9000	11500
40	80	23	1.1	22208EX	22208EXK	126000	102000	6700	8500
	80	23	1.1	22208AEX	22208AEXK	106000	81000	8500	10900
	90	23	1.5	21308E	21308EK	119000	95500	6000	7500
	90	23	1.5	21308AX	21308AXK	116000	84400	7500	9750
	90	33	1.5	22308EX	22308EXK	185000	151000	5300	6700
	90	33	1.5	22308AEX	22308AEXK	172000	134000	7800	10000
45	85	23	1.1	22209EX	22209EXK	133000	110000	6000	7500
	85	23	1.1	22209AEX	22209AEXK	113000	85500	7900	10200
	100	25	1.5	21309E	21309EK	150000	124000	5000	6300
	100	25	1.5	21309AX	21309AXK	143000	105000	6750	9000
	100	36	1.5	22309EX	22309EXK	230000	182000	4500	5600
	100	36	1.5	22309AEX	22309AEXK	208000	157000	7050	9150
50	90	23	1.1	22210EX	22210EXK	142000	122000	5600	7100
	90	23	1.1	22210AEX	22210AEXK	119000	93500	7350	9600
	110	27	2	21310E	21310EK	178000	151000	4500	5600
	110	27	2	21310AX	21310AXK	170000	127000	6000	8250
	110	40	2	22310EX	22310EXK	280000	235000	4300	5300
	110	40	2	22310AEX	22310AEXK	254000	205000	6300	8250
55	100	25	1.5	22211EX	22211EXK	171000	144000	5300	6700
	100	25	1.5	22211AEX	22211AEXK	150000	118000	6750	8550
	120	29	2	21311EX1	21311EX1K	200000	165000	4500	5600
	120	29	2	21311AX	21311AXK	206000	171000	6000	7500
	120	43	2	22311EX	22311EXK	325000	263000	3800	4800
	120	43	2	22311AEX	22311AEXK	294000	227000	6000	7650
60	110	28	1.5	22212EX	22212EXK	210000	179000	4800	6000
	110	28	1.5	22212AEX	22212AEXK	179000	144000	6150	7800
	130	31	2.1	21312EX1	21312EX1K	238000	193000	3800	4800
	130	31	2.1	21312AX	21312AXK	228000	192000	5250	6750
	130	46	2.1	22312EX	22312EXK	390000	330000	3600	4500
	130	46	2.1	22312AEX	22312AEXK	340000	275000	5400	6900

Note: Suffix K or K30 means tapered bore (1/12 or 1/30).

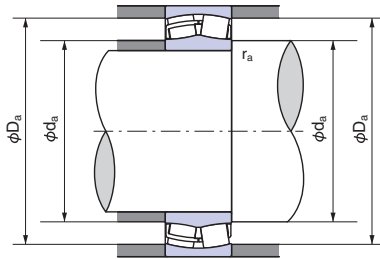

• Dynamic equivalent radial load
 $P_r = XFr + YFa$

$\frac{Fa}{Fr} \leq e$		$\frac{Fa}{Fr} > e$	
X	Y	X	Y
1	Y_1	0.67	Y_2

Values of Y_1 , Y_2 and e from table.

• Static equivalent radial load
 $P_{0r} = Fr + Y_0Fa$

Values Y_0 from table.

Dimensions of lubrication holes and grooves			Abutment and fillet dimensions (mm)			Constant e	Axial load factor			Mass (kg) Cylindrical bore (Reference)	Bearing No.	
Hole diameter do	Groove width A	Hole count N	da (min)	Da (max)	ra (max)		Y_1	Y_2	Y_0		Cylindrical bore	Tapered bore
3	6	4	27.0	45.0	1.0	0.31	2.20	3.27	2.15	0.18	21304E	21304EK
3	5	4	30.5	46.5	1.0	0.35	1.91	2.85	1.87	0.19	22205EX	22205EXK
3	5	4	30.5	46.5	1.0	0.43	1.57	2.33	1.53	0.18	22205AEX	22205AEXK
6	6	4	32.0	53.0	1.0	0.28	2.39	3.56	2.34	0.29	21305E	21305EK
3	5	4	35.5	56.5	1.0	0.33	2.04	3.04	2.00	0.30	22206EX	22206EXK
3	5	4	35.5	56.5	1.0	0.40	1.70	2.53	1.66	0.29	22206AEX	22206AEXK
3	5	4	38.0	65.0	1.0	0.27	2.49	3.71	2.43	0.43	21306E	21306EK
3	5	4	38.0	65.0	1.0	0.35	1.95	2.90	1.90	0.43	21306AX	21306AXK
3	6	4	42.0	65.0	1.0	0.32	2.10	3.13	2.06	0.46	22207EX	22207EXK
3	6	4	42.0	65.0	1.0	0.39	1.74	2.60	1.71	0.46	22207AEX	22207AEXK
3	5	4	44.0	71.0	1.5	0.27	2.49	3.71	2.43	0.57	21307E	21307EK
3	5	4	44.0	71.0	1.5	0.33	2.03	3.03	1.99	0.56	21307AX	21307AXK
3	6	4	43.5	71.5	1.5	0.48	1.41	2.10	1.38	0.78	22307AEX	22307AEXK
3	6	4	47.0	73.0	1.0	0.28	2.37	3.53	2.32	0.56	22208EX	22208EXK
3	6	4	47.0	73.0	1.0	0.34	1.99	2.96	1.94	0.56	22208AEX	22208AEXK
3	5	4	50.0	81.0	1.5	0.26	2.55	3.80	2.50	0.78	21308E	21308EK
3	5	4	50.0	81.0	1.5	0.32	2.09	3.11	2.04	0.79	21308AX	21308AXK
4	7	4	48.5	81.5	1.5	0.37	1.83	2.72	1.79	1.07	22308EX	22308EXK
4	7	4	48.5	81.5	1.5	0.43	1.55	2.31	1.54	1.05	22308AEX	22308AEXK
3	6	4	52.0	78.0	1.0	0.26	2.55	3.80	2.50	0.61	22209EX	22209EXK
3	6	4	52.0	78.0	1.0	0.31	2.15	3.21	2.11	0.60	22209AEX	22209AEXK
3	5	4	55.0	92.0	1.5	0.26	2.62	3.90	2.56	1.05	21309E	21309EK
3	5	4	55.0	92.0	1.5	0.31	2.16	3.22	2.11	1.05	21309AX	21309AXK
4	8	4	53.5	91.5	1.5	0.37	1.83	2.72	1.79	1.41	22309EX	22309EXK
4	8	4	53.5	91.5	1.5	0.43	1.57	2.34	1.54	1.41	22309AEX	22309AEXK
3	6	4	57.0	83.0	1.0	0.24	2.79	4.15	2.73	0.65	22210EX	22210EXK
3	6	4	57.0	83.0	1.0	0.29	2.34	3.48	2.28	0.65	22210AEX	22210AEXK
3	5	4	61.0	101.0	2.0	0.25	2.71	4.04	2.65	1.36	21310E	21310EK
3	5	4	61.0	101.0	2.0	0.30	2.24	3.34	2.19	1.36	21310AX	21310AXK
4	8	4	60.0	100.0	2.0	0.36	1.85	2.75	1.81	1.92	22310EX	22310EXK
4	8	4	60.0	100.0	2.0	0.42	1.62	2.42	1.59	1.88	22310AEX	22310AEXK
3	6	4	63.5	91.5	1.5	0.24	2.84	4.23	2.78	0.88	22211EX	22211EXK
3	6	4	63.5	91.5	1.5	0.29	2.34	3.48	2.28	0.89	22211AEX	22211AEXK
3	5	4	65.0	110.0	2.0	0.25	2.71	4.03	2.65	1.70	21311EX1	21311EX1K
3	5	4	65.0	110.0	2.0	0.29	2.32	3.45	2.27	1.77	21311AX	21311AXK
4	8	4	65.0	110.0	2.0	0.36	1.85	2.75	1.81	2.40	22311EX	22311EXK
4	8	4	65.0	110.0	2.0	0.43	1.56	2.33	1.53	2.39	22311AEX	22311AEXK
3	6	4	68.5	101.5	1.5	0.25	2.74	4.08	2.68	1.20	22212EX	22212EXK
3	6	4	68.5	101.5	1.5	0.29	2.29	3.41	2.24	1.22	22212AEX	22212AEXK
3	5	4	72.0	118.0	2.0	0.24	2.78	4.14	2.72	2.10	21312EX1	21312EX1K
3	5	4	72.0	118.0	2.0	0.29	2.36	3.52	2.31	2.19	21312AX	21312AXK
4	8	4	72.0	118.0	2.0	0.36	1.86	2.77	1.82	3.05	22312EX	22312EXK
4	8	4	72.0	118.0	2.0	0.41	1.65	2.46	1.62	3.01	22312AEX	22312AEXK

Spherical Roller Bearings

Bore Diameter : 65 ~ 95mm

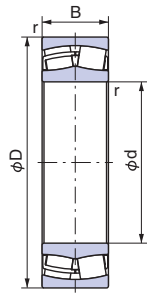

Cylindrical bore

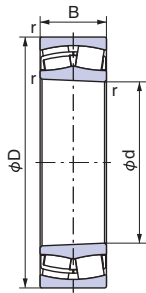

Tapered bore

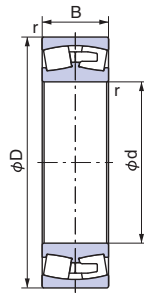

With machined brass cage

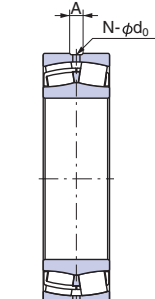

With oil holes / oil groove (W33)

1N=0.102kgf

d	Boundary dimensions (mm)			Bearing No.		Basic dynamic load rating Cr (N)	Basic static load rating Cor (N)	Limiting speed (min ⁻¹)	
	D	B	r (min)	Cylindrical bore	Tapered bore			Grease lubrication	Oil lubrication
65	120	31	1.5	22213EX	22213EXK	246000	209000	4300	5300
	120	31	1.5	22213AEX	22213AEXK	213000	169000	5700	7200
	140	33	2.1	21313EX1	21313EX1K	270000	232000	3600	4500
	140	33	2.1	21313AX	21313AXK	261000	222000	5100	6400
	140	48	2.1	22313EX	22313EXK	415000	355000	3200	4000
	140	48	2.1	22313AEX	22313AEXK	380000	310000	4950	6450
70	125	31	1.5	22214EX	22214EXK	257000	220000	4000	5300
	125	31	1.5	22214AEX	22214AEXK	225000	185000	5400	6900
	150	35	2.1	21314EX1	21314EX1K	310000	260000	3200	4000
	150	35	2.1	21314AX	21314AXK	305000	268000	4500	6000
	150	51	2.1	22314EX	22314EXK	480000	415000	3000	3800
150	51	2.1	22314AEX	22314AEXK	445000	365000	4650	6000	
75	130	31	1.5	22215EX	22215EXK	265000	234000	4000	5000
	130	31	1.5	22215AEX	22215AEXK	234000	191000	5100	6600
	160	37	2.1	21315EX1	21315EX1K	340000	298000	3200	4000
	160	37	2.1	21315AX	21315AXK	325000	286000	4350	5550
	160	55	2.1	22315EX	22315EXK	550000	475000	2800	3600
160	55	2.1	22315AEX	22315AEXK	495000	415000	4350	5500	
80	140	33	2	22216EX	22216EXK	299000	269000	3600	4500
	140	33	2	22216AEX	22216AEXK	279000	230000	4800	6100
	140	44.4	2	23216E	23216EK	335000	335000	3300	4350
	170	39	2.1	21316EX1	21316EX1K	380000	339000	3000	3800
	170	39	2.1	21316AX	21316AXK	355000	318000	4200	5250
	170	58	2.1	22316EX	22316EXK	595000	520000	2600	3400
170	58	2.1	22316AEX	22316AEXK	550000	465000	4050	5250	
85	150	36	2	22217EX	22217EXK	355000	320000	3400	4300
	150	36	2	22217AEX	22217AEXK	310000	260000	4200	5700
	150	49.2	2	23217E	23217EK	395000	405000	3150	4050
	180	41	3	21317EX1	21317EX1K	415000	372000	3000	4000
	180	41	3	21317AX	21317AXK	400000	364000	3900	5100
	180	60	3	22317EX	22317EXK	665000	585000	2400	3200
180	60	3	22317AEX	22317AEXK	590000	500000	3900	4950	
90	160	40	2	22218EX	22218EXK	410000	375000	3200	4000
	160	40	2	22218AEX	22218AEXK	360000	310000	4000	5400
	160	52.4	2	23218EX1	23218EX1K	470000	482000	3100	4200
	190	43	3	21318EX1	21318EX1K	460000	410000	2800	3600
	190	43	3	21318AX	21318AXK	460000	416000	3700	4800
	190	64	3	22318EX	22318EXK	745000	660000	2400	3000
190	64	3	22318AEX	22318AEXK	690000	585000	3700	4800	
95	170	43	2.1	22219EX	22219EXK	465000	420000	3000	3800
	170	43	2.1	22219AEX	22219AEXK	410000	360000	3900	5100
	170	55.6	2.1	23219E	23219EK	500000	510000	2800	3600
	200	45	3	21319EX1	21319EX1K	500000	461000	2700	3400
	200	45	3	21319AX	21319AXK	495000	450000	3400	4500
200	67	3	22319EX	22319EXK	815000	725000	2200	2900	
200	67	3	22319AEX	22319AEXK	755000	645000	3450	4500	

Note: Suffix K or K30 means tapered bore (1/12 or 1/30).

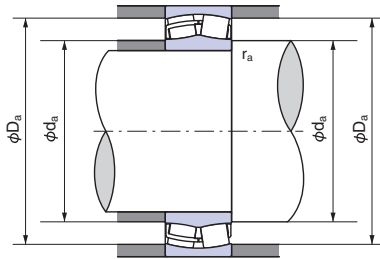

• Dynamic equivalent radial load
 $P_r = XFr + YFa$

$\frac{Fa}{Fr} \leq e$		$\frac{Fa}{Fr} > e$	
X	Y	X	Y
1	Y_1	0.67	Y_2

Values of Y_1 , Y_2 and e from table.

• Static equivalent radial load
 $P_{0r} = Fr + Y_0Fa$

Values Y_0 from table.

Dimensions of lubrication holes and grooves			Abutment and fillet dimensions (mm)			Constant e	Axial load factor			Mass (kg) Cylindrical bore (Reference)	Bearing No.	
Hole diameter do	Groove width A	Hole count N	da (min)	Da (max)	ra (max)		Y_1	Y_2	Y_0		Cylindrical bore	Tapered bore
3	6	4	73.5	111.5	1.5	0.25	2.69	4.00	2.63	1.56	22213EX	22213EXK
3	6	4	73.5	111.5	1.5	0.30	2.26	3.36	2.21	1.60	22213AEX	22213AEXK
3	6	4	77.0	128.0	2.0	0.24	2.83	4.21	2.76	2.60	21313EX1	21313EX1K
3	6	4	77.0	128.0	2.0	0.28	2.40	3.57	2.35	2.69	21313AX	21313AXK
4	8	4	77.0	128.0	2.0	0.34	1.98	2.94	1.93	3.67	22313EX	22313EXK
4	8	4	77.0	128.0	2.0	0.39	1.72	2.55	1.68	3.64	22313AEX	22313AEXK
3	6	4	78.5	116.5	1.5	0.24	2.87	4.27	2.80	1.65	22214EX	22214EXK
3	6	4	78.5	116.5	1.5	0.28	2.39	3.55	2.33	1.69	22214AEX	22214AEXK
3	6	4	82.0	138.0	2.0	0.24	2.84	4.23	2.78	3.10	21314EX1	21314EX1K
3	6	4	82.0	138.0	2.0	0.28	2.45	3.64	2.39	3.30	21314AX	21314AXK
5	10	4	82.0	138.0	2.0	0.34	1.98	2.94	1.93	4.45	22314EX	22314EXK
5	10	4	82.0	138.0	2.0	0.40	1.71	2.54	1.67	4.46	22314AEX	22314AEXK
3	6	4	83.5	121.5	1.5	0.22	3.07	4.58	3.01	1.74	22215EX	22215EXK
3	6	4	83.5	121.5	1.5	0.27	2.51	3.73	2.46	1.76	22215AEX	22215AEXK
3	6	4	87.0	148.0	2.0	0.23	2.87	4.27	2.80	3.80	21315EX1	21315EX1K
3	6	4	87.0	148.0	2.0	0.27	2.50	3.72	2.44	3.95	21315AX	21315AXK
5	10	4	87.0	148.0	2.0	0.35	1.95	2.90	1.91	5.44	22315EX	22315EXK
5	10	4	87.0	148.0	2.0	0.39	1.72	2.56	1.68	5.44	22315AEX	22315AEXK
3	6	4	90.0	130.0	2.0	0.22	3.07	4.58	3.01	2.19	22216EX	22216EXK
3	6	4	90.0	130.0	2.0	0.27	2.51	3.74	2.46	2.24	22216AEX	22216AEXK
4	8	4	90.0	130.0	2.0	0.29	2.35	3.50	2.30	2.95	23216E	23216EK
4	8	4	92.0	158.0	2.0	0.23	2.88	4.29	2.82	4.50	21316EX1	21316EX1K
4	8	4	92.0	158.0	2.0	0.26	2.55	3.80	2.50	4.67	21316AX	21316AXK
5	10	4	92.0	158.0	2.0	0.35	1.95	2.90	1.91	6.42	22316EX	22316EXK
5	10	4	92.0	158.0	2.0	0.38	1.75	2.61	1.72	6.43	22316AEX	22316AEXK
4	7	4	95.0	140.0	2.0	0.22	3.01	4.48	2.94	2.75	22217EX	22217EXK
4	7	4	95.0	140.0	2.0	0.27	2.47	3.67	2.41	2.82	22217AEX	22217AEXK
4	8	4	95.0	140.0	2.0	0.30	2.24	3.34	2.19	3.78	23217E	23217EK
4	8	4	99.0	166.0	2.5	0.23	2.89	4.30	2.83	5.30	21317EX1	21317EX1K
4	8	4	99.0	166.0	2.5	0.26	2.55	3.79	2.49	5.52	21317AX	21317AXK
6	11	4	99.0	166.0	2.5	0.33	2.02	3.00	1.97	7.46	22317EX	22317EXK
6	11	4	99.0	166.0	2.5	0.38	1.78	2.65	1.74	7.47	22317AEX	22317AEXK
4	7	4	100.0	150.0	2.0	0.24	2.79	4.15	2.73	3.50	22218EX	22218EXK
4	7	4	100.0	150.0	2.0	0.28	2.42	3.60	2.36	3.56	22218AEX	22218AEXK
5	10	4	100.0	150.0	2.0	0.32	2.14	3.19	2.09	4.57	23218EX1	23218EX1K
4	8	6	104.0	176.0	2.5	0.23	2.91	4.33	2.84	6.10	21318EX1	21318EX1K
4	8	6	104.0	176.0	2.5	0.26	2.55	3.80	2.50	6.45	21318AX	21318AXK
6	11	6	104.0	176.0	2.5	0.34	2.00	2.98	1.96	8.82	22318EX	22318EXK
6	11	6	104.0	176.0	2.5	0.39	1.73	2.57	1.69	8.91	22318AEX	22318AEXK
5	8	4	107.0	158.0	2.0	0.24	2.76	4.11	2.70	4.24	22219EX	22219EXK
5	8	4	107.0	158.0	2.0	0.28	2.38	3.55	2.33	4.35	22219AEX	22219AEXK
5	10	4	107.0	158.0	2.0	0.30	2.24	3.34	2.19	5.46	23219E	23219EK
4	8	6	109.0	186.0	2.5	0.23	2.92	4.35	2.86	7.10	21319EX1	21319EX1K
4	8	6	109.0	186.0	2.5	0.27	2.54	3.79	2.49	7.44	21319AX	21319AXK
6	12	6	109.0	186.0	2.5	0.33	2.02	3.00	1.97	10.2	22319EX	22319EXK
6	12	6	109.0	186.0	2.5	0.39	1.74	2.59	1.70	10.3	22319AEX	22319AEXK

Spherical Roller Bearings

Bore Diameter : 100 ~ 120mm

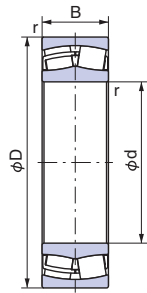

Cylindrical bore

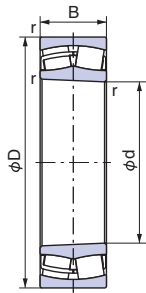

Tapered bore

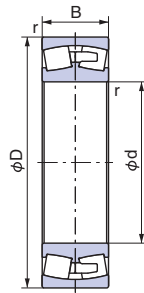

With machined brass cage

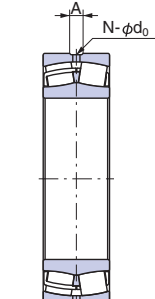

With oil holes / oil groove (W33)

1N=0.102kgf

d	Boundary dimensions (mm)			Bearing No.		Basic dynamic load rating Cr (N)	Basic static load rating Cor (N)	Limiting speed (min ⁻¹)	
	D	B	r (min)	Cylindrical bore	Tapered bore			Grease lubrication	Oil lubrication
100	140	30	1.1	23920E	23920EK	197000	233000	3400	4500
	150	37	1.5	23020E	23020EK	286000	325000	2700	3700
	150	37	1.5	23020AX	23020AXK	267000	298000	4200	5400
	165	52	2	23120EX1	23120EX1K	450000	500000	2500	3300
	165	52	2	23120AX	23120AXK	450000	538000	3300	4500
	180	46	2.1	22220EX	22220EXK	520000	480000	2800	3600
	180	46	2.1	22220AEX	22220AEXK	465000	410000	3700	4800
	180	60.3	2.1	23220EX1	23220EX1K	595000	629000	2800	3750
	180	60.3	2.1	23220AX	23220AXK	575000	599000	3100	4200
	215	47	3	21320EX1	21320EX1K	580000	524000	2400	3300
	215	47	3	21320AX	21320AXK	545000	488000	3300	4200
	215	73	3	22320EX	22320EXK	975000	875000	2000	2800
215	73	3	22320AEX	22320AEXK	890000	775000	3300	4200	
110	170	45	2	23022E	23022EK	415000	475000	2700	3600
	170	45	2	23022AX	23022AXK	415000	478000	3750	4800
	180	56	2	23122EX1	23122EX1K	540000	610000	2700	3600
	180	56	2	23122AX	23122AXK	535000	605000	3000	4050
	180	69	2	24122EX1	24122EX1K30	633000	743000	2700	3600
	180	69	2	24122AX	24122AXK30	620000	654000	2700	3600
	200	53	2.1	22222EX	22222EXK	680000	640000	2600	3200
	200	53	2.1	22222AEX	22222AEXK	605000	550000	3300	4350
	200	69.8	2.1	23222EX1	23222EX1K	750000	793000	2550	3300
	200	69.8	2.1	23222AX	23222AXK	740000	801000	2850	3750
	240	50	3	21322EX1	21322EX1K	675000	635000	2100	2850
	240	50	3	21322AX	21322AXK	655000	601000	3000	3750
240	80	3	22322EX	22322EXK	1150000	1040000	1950	2700	
240	80	3	22322AEX	22322AEXK	1030000	940000	3000	3750	
120	180	46	2	23024E	23024EK	430000	515000	2550	3300
	180	46	2	23024AX	23024AXK	430000	516000	3450	4500
	180	60	2	24024EX1	24024EX1K30	540000	683000	2550	3450
	180	60	2	24024AX	24024AXK30	540000	627000	2550	3450
	200	62	2	23124EX1	23124EX1K	675000	720000	2400	3300
	200	62	2	23124AX	23124AXK	645000	734000	2700	3600
	200	80	2	24124EX1	24124EX1K30	815000	970000	2400	3300
	200	80	2	24124AX	24124AXK30	780000	850000	2400	3300
	215	58	2.1	22224EX	22224EXK	785000	765000	2400	3000
	215	58	2.1	22224AEX	22224AEXK	700000	650000	3150	4050
	215	76	2.1	23224EX1	23224EX1K	860000	956000	2250	3150
	215	76	2.1	23224AX	23224AXK	860000	962000	2550	3450
260	55	3	21324E	21324EK	790000	765000	1950	2400	
260	86	3	22324EX	22324EXK	1250000	1130000	1800	2600	
260	86	3	22324AEX	22324AEXK	1180000	1040000	2700	3450	

Note: Suffix K or K30 means tapered bore (1/12 or 1/30).

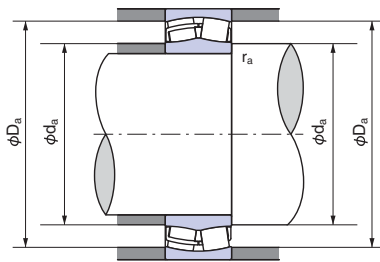

• Dynamic equivalent radial load
 $P_r = XFr + YFa$

$\frac{Fa}{Fr} \leq e$		$\frac{Fa}{Fr} > e$	
X	Y	X	Y
1	Y_1	0.67	Y_2

Values of Y_1 , Y_2 and e from table.

• Static equivalent radial load
 $P_{0r} = Fr + Y_0Fa$

Values Y_0 from table.

Dimensions of lubrication holes and grooves			Abutment and fillet dimensions (mm)			Constant e	Axial load factor			Mass (kg) Cylindrical bore (Reference)	Bearing No.	
Hole diameter d_o	Groove width A	Hole count N	d_a (min)	D_a (max)	r_a (max)		Y_1	Y_2	Y_0		Cylindrical bore	Tapered bore
3	8	4	107.0	133.0	1.0	0.20	3.42	5.08	3.34	1.46	23920E	23920EK
4	7	4	117.0	141.0	1.5	0.22	3.01	4.48	2.94	2.33	23020E	23020EK
4	7	4	117.0	141.0	1.5	0.26	2.64	3.93	2.58	2.40	23020AX	23020AXK
5	9	4	110.0	155.0	2.0	0.29	2.33	3.47	2.28	4.49	23120EX1	23120EX1K
5	9	4	110.0	155.0	2.0	0.34	1.98	2.94	1.93	4.70	23120AX	23120AXK
5	8	4	112.0	168.0	2.0	0.25	2.74	4.08	2.68	5.10	22220EX	22220EXK
5	8	4	112.0	168.0	2.0	0.29	2.37	3.52	2.31	5.24	22220AEX	22220AEXK
5	10	4	112.0	168.0	2.0	0.32	2.09	3.11	2.04	6.76	23220EX1	23220EX1K
5	10	4	112.0	168.0	2.0	0.36	1.88	2.80	1.84	6.88	23220AX	23220AXK
4	8	6	114.0	201.0	2.5	0.22	3.02	4.49	2.95	8.70	21320EX1	21320EX1K
4	8	6	114.0	201.0	2.5	0.26	2.62	3.91	2.57	9.06	21320AX	21320AXK
6	12	6	114.0	201.0	2.5	0.35	1.95	2.90	1.91	13.1	22320EX	22320EXK
6	12	6	114.0	201.0	2.5	0.39	1.72	2.57	1.69	13.2	22320AEX	22320AEXK
5	9	4	120.0	160.0	2.0	0.24	2.84	4.23	2.78	3.84	23022E	23022EK
5	9	4	120.0	160.0	2.0	0.28	2.42	3.61	2.37	3.90	23022AX	23022AXK
5	9	4	120.0	170.0	2.0	0.29	2.36	3.51	2.31	5.70	23122EX1	23122EX1K
5	9	4	120.0	170.0	2.0	0.33	2.04	3.03	1.99	5.80	23122AX	23122AXK
6	11	4	120.0	170.0	2.0	0.37	1.84	2.74	1.80	6.89	24122EX1	24122EX1K30
6	11	4	120.0	170.0	2.0	0.37	1.80	2.69	1.76	6.85	24122AX	24122AXK30
5	10	6	122.0	188.0	2.0	0.26	2.64	3.93	2.58	7.36	22222EX	22222EXK
6	10	6	122.0	188.0	2.0	0.29	2.31	3.44	2.26	7.53	22222AEX	22222AEXK
6	11	6	122.0	188.0	2.0	0.34	1.99	2.96	1.94	9.60	23222EX1	23222EX1K
6	11	6	122.0	188.0	2.0	0.38	1.78	2.65	1.74	10.0	23222AX	23222AXK
4	8	6	124.0	226.0	2.5	0.21	3.19	4.75	3.12	11.6	21322EX1	21322EX1K
4	8	6	124.0	226.0	2.5	0.24	2.78	4.14	2.72	12.2	21322AX	21322AXK
6	12	6	124.0	226.0	2.5	0.33	2.03	3.02	1.98	18.1	22322EX	22322EXK
6	12	6	124.0	226.0	2.5	0.38	1.77	2.63	1.73	18.2	22322AEX	22322AEXK
5	9	4	130.0	170.0	2.0	0.23	2.95	4.39	2.89	4.20	23024E	23024EK
5	9	4	130.0	170.0	2.0	0.27	2.52	3.76	2.47	4.20	23024AX	23024AXK
5	9	4	130.0	170.0	2.0	0.30	2.23	3.32	2.18	5.36	24024EX1	24024EX1K30
5	9	4	130.0	170.0	2.0	0.31	2.21	3.29	2.16	5.26	24024AX	24024AXK30
5	9	6	130.0	190.0	2.0	0.29	2.34	3.49	2.29	7.90	23124EX1	23124EX1K
5	9	6	130.0	190.0	2.0	0.34	2.00	2.99	1.96	8.10	23124AX	23124AXK
6	11	6	130.0	190.0	2.0	0.38	1.78	2.65	1.74	10.1	24124EX1	24124EX1K30
6	11	6	130.0	190.0	2.0	0.39	1.73	2.58	1.69	9.90	24124AX	24124AXK30
5	10	6	132.0	203.0	2.0	0.26	2.60	3.87	2.54	9.28	22224EX	22224EXK
5	10	6	132.0	203.0	2.0	0.30	2.28	3.40	2.23	9.35	22224AEX	22224AEXK
6	13	6	132.0	203.0	2.0	0.34	1.97	2.94	1.93	12.0	23224EX1	23224EX1K
6	13	6	132.0	203.0	2.0	0.39	1.73	2.57	1.69	12.3	23224AX	23224AXK
5	12	6	134.0	246.0	2.5	0.21	3.17	4.72	3.10	15.3	21324E	21324EK
8	14	6	134.0	246.0	2.5	0.33	2.03	3.02	1.98	22.6	22324EX	22324EXK
8	14	6	134.0	246.0	2.5	0.38	1.77	2.64	1.73	22.2	22324AEX	22324AEXK

Spherical Roller Bearings

Bore Diameter : 130 ~ 150mm

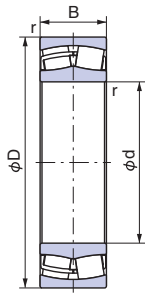

Cylindrical bore

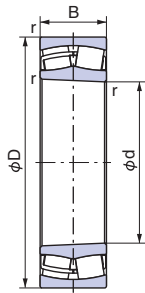

Tapered bore

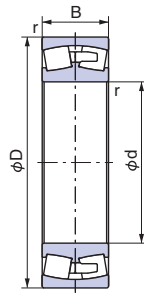

With machined brass cage

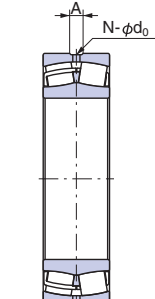

With oil holes / oil groove (W33)

1N=0.102kgf

Boundary dimensions (mm)				Bearing No.		Basic dynamic load rating Cr (N)	Basic static load rating Cor (N)	Limiting speed (min ⁻¹)	
d	D	B	r (min)	Cylindrical bore	Tapered bore			Grease lubrication	Oil lubrication
130	180	37	1.5	23926E	23926EK	284000	355000	2700	3450
	200	52	2	23026E	23026EK	555000	660000	2400	3000
	200	52	2	23026AX	23026AXK	560000	664000	3150	4050
	200	69	2	24026EX1	24026EX1K30	710000	900000	2400	3150
	200	69	2	24026AX	24026AXK30	680000	803000	2400	3150
	210	64	2	23126EX1	23126EX1K	690000	799000	2200	3000
	210	64	2	23126AX	23126AXK	705000	827000	2500	3300
	210	80	2	24126EX1	24126EX1K30	840000	1030000	2200	3000
	210	80	2	24126AX	24126AXK30	815000	918000	2200	3000
	230	64	3	22226EX	22226EXK	910000	915000	2200	2600
	230	64	3	22226AEX	22226AEXK	815000	765000	2800	3700
	230	80	3	23226EX1	23226EX1K	980000	1090000	2100	2800
	230	80	3	23226AX	23226AXK	965000	1070000	2400	3100
	280	93	4	22326EX	22326EXK	1450000	1340000	1700	2500
	280	93	4	22326AEX	22326AEXK	1370000	1220000	2500	3300
	140	190	37	1.5	23928AX	23928AXK	345000	466000	2550
210		53	2	23028E	23028EK	585000	710000	2400	2800
210		53	2	23028AX	23028AXK	580000	711000	3000	3900
210		69	2	24028EX1	24028EX1K30	720000	920000	2200	3000
210		69	2	24028AX	24028AXK30	720000	819000	2200	3000
225		68	2.1	23128EX1	23128EX1K	790000	940000	2100	2850
225		68	2.1	23128AX	23128AXK	790000	934000	2200	3100
225		85	2.1	24128EX1	24128EX1K30	950000	1180000	2100	2800
225		85	2.1	24128AX	24128AXK30	930000	1030000	2100	2800
250		68	3	22228EX	22228EXK	1050000	1030000	1900	2500
250		68	3	22228AEX	22228AEXK	945000	890000	2700	3400
250		88	3	23228EX1	23228EX1K	1130000	1290000	1900	2500
250		88	3	23228AX	23228AXK	1120000	1270000	2200	2800
300		102	4	22328E	22328EK	1540000	1520000	1600	2200
300		102	4	22328A2X	22328A2XK	1560000	1540000	2200	3000
150		210	45	2	23930AX	23930AXK	465000	622000	2400
	225	56	2.1	23030E	23030EK	640000	790000	1900	2500
	225	56	2.1	23030AX	23030AXK	640000	791000	2700	3600
	225	72	2.1	24030EX1	24030EX1K30	815000	1060000	2100	2700
	225	75	2.1	24030AX	24030AXK30	815000	924000	2100	2700
	250	80	2.1	23130EX1	23130EX1K	1000000	1230000	1900	2500
	250	80	2.1	23130AX	23130AXK	1030000	1310000	2100	2800
	250	100	2.1	24130EX1	24130EX1K	1230000	1520000	1900	2500
	250	100	2.1	24130AX	24130AXK30	1120000	1340000	1900	2500
	270	73	3	22230EX	22230EXK	1200000	1200000	1800	2400
	270	73	3	22230AEX	22230AEXK	1060000	1020000	2400	3100
	270	96	3	23230EX1	23230EX1K	1340000	1540000	1800	2400
	270	96	3	23230AX	23230AXK	1320000	1530000	1900	2700
	320	108	4	22330E	22330EK	1770000	1740000	1500	2100
	320	108	4	22330A2X	22330A2XK	1720000	1710000	2100	2800

Note: Suffix K or K30 means tapered bore (1/12 or 1/30).

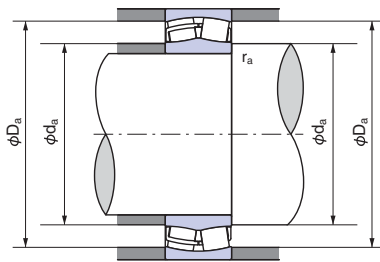

• Dynamic equivalent radial load
 $P_r = XFr + YFa$

$\frac{Fa}{Fr} \leq e$		$\frac{Fa}{Fr} > e$	
X	Y	X	Y
1	Y_1	0.67	Y_2

Values of Y_1 , Y_2 and e from table.

• Static equivalent radial load
 $P_{0r} = Fr + Y_0Fa$

Values Y_0 from table.

Dimensions of lubrication holes and grooves			Abutment and fillet dimensions (mm)			Constant e	Axial load factor			Mass (kg) Cylindrical bore (Reference)	Bearing No.	
Hole diameter d_o	Groove width A	Hole count N	d_a (min)	D_a (max)	r_a (max)		Y_1	Y_2	Y_0		Cylindrical bore	Tapered bore
4	8	4	138.5	171.5	1.5	0.18	3.66	5.46	3.58	2.87	23926E	23926EK
5	10	6	140.0	190.0	2.0	0.24	2.87	4.27	2.80	6.14	23026E	23026EK
5	10	6	140.0	190.0	2.0	0.27	2.50	3.72	2.44	6.10	23026AX	23026AXK
6	11	6	140.0	190.0	2.0	0.32	2.14	3.18	2.09	7.93	24026EX1	24026EX1K30
6	11	6	140.0	190.0	2.0	0.33	2.04	3.04	2.00	7.77	24026AX	24026AXK30
5	9	6	140.0	200.0	2.0	0.28	2.42	3.61	2.37	8.60	23126EX1	23126EX1K
5	9	6	140.0	200.0	2.0	0.30	2.25	3.34	2.20	8.90	23126AX	23126AXK
6	11	6	140.0	200.0	2.0	0.36	1.90	2.83	1.86	10.7	24126EX1	24126EX1K30
6	11	6	140.0	200.0	2.0	0.37	1.83	2.72	1.79	10.5	24126AX	24126AXK30
5	10	6	144.0	216.0	2.5	0.26	2.55	3.80	2.50	11.6	22226EX	22226EXK
5	10	6	144.0	216.0	2.5	0.30	2.22	3.30	2.17	11.6	22226AEX	22226AEXK
6	13	6	144.0	216.0	2.5	0.33	2.05	3.05	2.00	14.2	23226EX1	23226EX1K
6	13	6	144.0	216.0	2.5	0.38	1.78	2.65	1.74	14.5	23226AX	23226AXK
8	16	6	148.0	262.0	3.0	0.33	2.03	3.02	1.98	28.4	22326EX	22326EXK
8	16	6	148.0	262.0	3.0	0.38	1.77	2.64	1.73	27.3	22326AEX	22326AEXK
4	7	6	148.5	181.5	1.5	0.18	3.79	5.65	3.71	3.13	23928AX	23928AXK
5	10	6	150.0	200.0	2.0	0.23	2.98	4.44	2.91	6.61	23028E	23028EK
5	10	6	150.0	200.0	2.0	0.25	2.75	4.10	2.69	6.70	23028AX	23028AXK
6	11	6	150.0	200.0	2.0	0.30	2.28	3.39	2.23	8.40	24028EX1	24028EX1K30
6	11	6	150.0	200.0	2.0	0.31	2.15	3.20	2.10	8.22	24028AX	24028AXK30
6	11	6	152.0	213.0	2.0	0.28	2.45	3.65	2.40	10.5	23128EX1	23128EX1K
6	11	6	152.0	213.0	2.0	0.30	2.27	3.37	2.22	10.8	23128AX	23128AXK
8	14	6	152.0	213.0	2.0	0.36	1.87	2.79	1.83	13.0	24128EX1	24128EX1K30
8	14	6	152.0	213.0	2.0	0.36	1.87	2.79	1.83	12.7	24128AX	24128AXK30
6	12	6	154.0	236.0	2.5	0.26	2.60	3.87	2.54	13.9	22228EX	22228EXK
6	12	6	154.0	236.0	2.5	0.30	2.26	3.37	2.21	14.8	22228AEX	22228AEXK
8	15	6	154.0	236.0	2.5	0.34	1.99	2.96	1.95	18.8	23228EX1	23228EX1K
8	16	6	154.0	236.0	2.5	0.38	1.78	2.65	1.74	19.3	23228AX	23228AXK
10	22	6	158.0	282.0	3.0	0.37	1.82	2.72	1.78	35.9	22328E	22328EK
10	22	6	158.0	282.0	3.0	0.40	1.69	2.52	1.65	34.5	22328A2X	22328A2XK
5	9	6	200.0	160.0	2.0	0.20	3.44	5.12	3.36	5.01	23930AX	23930AXK
5	11	6	162.0	213.0	2.0	0.22	3.04	4.53	2.97	8.01	23030E	23030EK
5	11	6	162.0	213.0	2.0	0.24	2.79	4.16	2.73	8.20	23030AX	23030AXK
6	11	6	162.0	213.0	2.0	0.30	2.23	3.32	2.18	10.5	24030EX1	24030EX1K
6	11	6	162.0	213.0	2.0	0.32	2.10	3.13	2.06	10.4	24030AX	24030AXK30
6	13	6	162.0	238.0	2.0	0.30	2.24	3.34	2.19	16.2	23130EX1	23130EX1K
6	13	6	162.0	238.0	2.0	0.35	1.95	2.91	1.91	16.7	23130AX	23130AXK
8	14	6	162.0	238.0	2.0	0.38	1.77	2.64	1.73	19.6	24130EX1	24130EX1K
8	14	6	162.0	238.0	2.0	0.38	1.76	2.62	1.72	19.5	24130AX	24130AXK30
6	14	6	164.0	256.0	2.5	0.25	2.69	4.00	2.63	18.9	22230EX	22230EXK
6	14	6	164.0	256.0	2.5	0.29	2.30	3.42	2.25	18.1	22230AEX	22230AEXK
8	15	6	164.0	256.0	2.5	0.34	1.96	2.93	1.92	24.2	23230EX1	23230EX1K
8	15	6	164.0	256.0	2.5	0.40	1.70	2.53	1.66	24.8	23230AX	23230AXK
10	22	6	168.0	302.0	3.0	0.37	1.82	2.70	1.78	43.3	22330E	22330EK
10	22	6	168.0	302.0	3.0	0.40	1.67	2.49	1.63	41.5	22330A2X	22330A2XK

Spherical Roller Bearings

Bore Diameter : 160 ~ 170mm

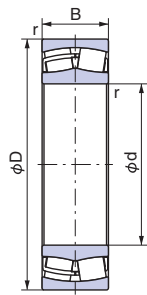

Cylindrical bore

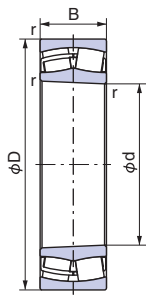

Tapered bore

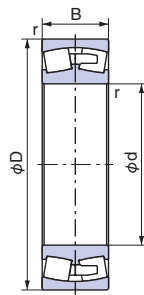

With machined brass cage

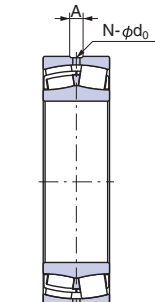

With oil holes / oil groove (W33)

1N=0.102kgf

d	Boundary dimensions (mm)			Bearing No.		Basic dynamic load rating Cr (N)	Basic static load rating Cor (N)	Limiting speed (min ⁻¹)	
	D	B	r (min)	Cylindrical bore	Tapered bore			Grease lubrication	Oil lubrication
160	220	45	2	23932AX	23932AXK	475000	649000	2250	2800
	240	60	2.1	23032E	23032EK	735000	915000	1800	2400
	240	60	2.1	23032AX	23032AXK	735000	917000	2500	3300
	240	80	2.1	24032EX1	24032EX1K30	950000	1280000	1900	2500
	240	80	2.1	24032AX	24032AXK30	915000	1110000	1900	2500
	270	86	2.1	23132EX1	23132EX1K	1180000	1430000	1800	2400
	270	86	2.1	23132AX	23132AXK	1200000	1460000	1900	2500
	270	109	2.1	24132EX1	24132EX1K30	1450000	1810000	1800	2400
	270	109	2.1	24132AX	24132AXK30	1340000	1610000	1800	2400
	290	80	3	22232E	22232EK	1230000	1330000	1500	2100
	290	80	3	22232E2	22232E2K	1230000	1320000	1800	2400
	290	80	3	22232A2X	22232A2XK	1210000	1300000	2200	3000
	290	104	3	23232E	23232EK	1500000	1710000	1300	1800
	290	104	3	23232A2X	23232A2XK	1460000	1650000	1900	2400
340	114	4	22332E	22332EK	1950000	1950000	1400	1900	
170	230	45	2	23934AX	23934AXK	490000	691000	2100	2700
	260	67	2.1	23034E	23034EK	880000	1080000	1600	2200
	260	67	2.1	23034AX	23034AXK	880000	1080000	2400	3100
	260	90	2.1	24034EX1	24034EX1K	1120000	1480000	1800	2400
	260	90	2.1	24034AX	24034AXK30	1030000	1320000	1800	2400
	280	88	2.1	23134EX1	23134EX1K	1260000	1530000	1600	2200
	280	88	2.1	23134AX	23134AXK	1260000	1500000	1800	2400
	280	109	2.1	24134AX	24134AXK30	1360000	1650000	1600	2200
	310	86	4	22234E	22234EK	1390000	1510000	1400	1900
	310	110	4	23234E	23234EK	1720000	1970000	1300	1800
	310	110	4	23234A2X	23234A2XK	1680000	1910000	1800	2250
	360	120	4	22334E	22334EK	2150000	2200000	1300	1800

Note: Suffix K or K30 means tapered bore (1/12 or 1/30).

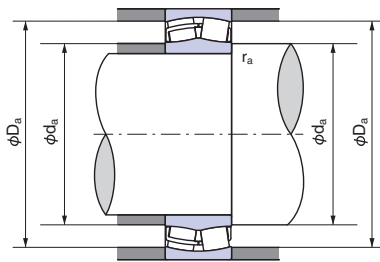

• Dynamic equivalent radial load
 $P_r = XFr + YFa$

$\frac{Fa}{Fr} \leq e$		$\frac{Fa}{Fr} > e$	
X	Y	X	Y
1	Y_1	0.67	Y_2

Values of Y_1 , Y_2 and e from table.

• Static equivalent radial load
 $P_{0r} = Fr + Y_0Fa$

Values Y_0 from table.

Dimensions of lubrication holes and grooves			Abutment and fillet dimensions (mm)			Constant e	Axial load factor			Mass (kg) Cylindrical bore (Reference)	Bearing No.	
Hole diameter do	Groove width A	Hole count N	da (min)	Da (max)	ra (max)		Y_1	Y_2	Y_0		Cylindrical bore	Tapered bore
5	10	6	170.0	210.0	2.0	0.19	3.60	5.37	3.52	5.29	23932AX	23932AXK
5	11	6	172.0	228.0	2.0	0.22	3.01	4.48	2.94	9.74	23032E	23032EK
5	11	6	172.0	228.0	2.0	0.24	2.79	4.16	2.73	9.90	23032AX	23032AXK
6	11	6	172.0	228.0	2.0	0.30	2.24	3.34	2.19	12.7	24032EX1	24032EX1K30
6	11	6	172.0	228.0	2.0	0.32	2.12	3.15	2.07	12.4	24032AX	24032AXK30
8	16	6	172.0	258.0	2.0	0.30	2.22	3.30	2.17	20.5	23132EX1	23132EX1K
8	16	6	172.0	258.0	2.0	0.34	1.96	2.91	1.91	21.2	23132AX	23132AXK
10	17	6	172.0	258.0	2.0	0.39	1.74	2.59	1.70	25.5	24132EX1	24132EX1K30
10	17	6	172.0	258.0	2.0	0.39	1.74	2.59	1.70	25.5	24132AX	24132AXK30
6	14	6	174.0	276.0	2.5	0.26	2.57	3.83	2.52	23.7	22232E	22232EK
6	14	6	174.0	276.0	2.5	0.28	2.37	3.53	2.32	24.0	22232E2	22232E2K
6	14	6	174.0	276.0	2.5	0.31	2.20	3.27	2.15	23.8	22232A2X	22232A2XK
10	22	6	174.0	276.0	2.5	0.37	1.82	2.71	1.78	30.4	23232E	23232EK
10	22	6	174.0	276.0	2.5	0.39	1.72	2.56	1.68	30.7	23232A2X	23232A2XK
10	22	6	178.0	322.0	3.0	0.36	1.85	2.75	1.81	51.4	22332E	22332EK
5	10	6	180.0	220.0	2.0	0.18	3.78	5.63	3.70	5.58	23934AX	23934AXK
6	13	6	182.0	248.0	2.0	0.23	2.89	4.31	2.83	13.1	23034E	23034EK
6	13	6	182.0	248.0	2.0	0.27	2.51	3.74	2.45	13.1	23034AX	23034AXK
8	14	6	182.0	248.0	2.0	0.32	2.11	3.15	2.07	17.3	24034EX1	24034EX1K
8	14	6	182.0	248.0	2.0	0.34	2.00	2.97	1.95	17.0	24034AX	24034AXK30
8	16	6	182.0	268.0	2.0	0.29	2.30	3.43	2.25	21.6	23134EX1	23134EX1K
8	16	6	182.0	268.0	2.0	0.34	2.01	3.00	1.97	22.2	23134AX	23134AXK
10	17	6	182.0	268.0	2.0	0.37	1.82	2.70	1.78	26.4	24134AX	24134AXK30
8	18	6	188.0	292.0	3.0	0.29	2.33	3.47	2.28	30.0	22234E	22234EK
10	22	6	188.0	292.0	3.0	0.36	1.85	2.75	1.81	37.0	23234E	23234EK
10	22	6	188.0	292.0	3.0	0.39	1.71	2.54	1.67	37.6	23234A2X	23234A2XK
10	22	6	188.0	342.0	3.0	0.36	1.85	2.75	1.81	60.6	22334E	22334EK

Spherical Roller Bearings

Bore Diameter : 180 ~ 220mm

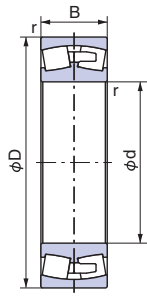

Cylindrical bore

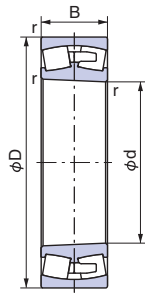

Tapered bore

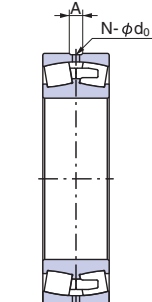

With oil holes / oil groove (W33)

1N=0.102kgf

d	Boundary dimensions (mm)			Bearing No.		Basic dynamic load rating Cr (N)	Basic static load rating Cor (N)	Limiting speed (min ⁻¹)	
	D	B	r (min)	Cylindrical bore	Tapered bore			Grease lubrication	Oil lubrication
180	250	52	2	23936AX	23936AXK	665000	939000	1900	2500
	280	74	2.1	23036E	23036EK	1070000	1330000	1500	2200
	280	74	2.1	23036AX	23036AXK	1040000	1280000	2200	2800
	280	100	2.1	24036EX1	24036EX1K	1330000	1760000	1600	2100
	280	100	2.1	24036AX	24036AXK30	1230000	1580000	1600	2100
	300	96	3	23136E	23136EK	1490000	1810000	1300	1800
	300	96	3	23136A2X	23136A2XK	1450000	1740000	1800	2200
	300	118	3	24136E	24136EK30	1640000	2040000	1350	1800
	320	86	4	22236E	22236EK	1460000	1610000	1400	1900
	320	112	4	23236E	23236EK	1790000	2100000	1200	1600
	320	112	4	23236A2X	23236A2XK	1750000	2070000	1800	2200
	380	126	4	22336E	22336EK	2380000	2400000	1200	1600
190	260	52	2	23938AX	23938AXK	675000	969000	1800	2400
	290	75	2.1	23038E	23038EK	1080000	1330000	1400	1900
	290	75	2.1	23038A2X	23038A2XK	1080000	1310000	2100	2800
	290	100	2.1	24038E	24038EK30	1420000	1920000	1300	1800
	320	104	3	23138E	23138EK	1720000	2120000	1200	1600
	320	104	3	23138A2X	23138A2XK	1710000	2090000	1600	2100
	320	128	3	24138E	24138EK30	1900000	2380000	1200	1600
	340	92	4	22238E	22238EK	1590000	1740000	1300	1800
	340	120	4	23238E	23238EK	2070000	2450000	1200	1500
	340	120	4	23238A2X	23238A2XK	2000000	2370000	1600	2100
	400	132	5	22338E	22338EK	2600000	2670000	1200	1600
	200	280	60	2.1	23940AX	23940AXK	840000	1190000	1800
310		82	2.1	23040E	23040EK	1270000	1560000	1400	1900
310		82	2.1	23040A2X	23040A2XK	1270000	1570000	1900	2500
310		109	2.1	24040E	24040EK30	1640000	2230000	1200	1600
340		112	3	23140E	23140EK	1950000	2390000	1200	1500
340		112	3	23140A2X	23140A2XK	1900000	2330000	1600	2100
340		140	3	24140E	24140EK30	2220000	2820000	1200	1500
360		98	4	22240E	22240EK	1810000	1990000	1200	1600
360		128	4	23240E	23240EK	2290000	2750000	1200	1500
360		128	4	23240A2X	23240A2XK	2240000	2680000	1500	1900
420		138	5	22340E	22340EK	2890000	3000000	1200	1500
220		300	60	2.1	23944E	23944EK	840000	1190000	1300
	340	90	3	23044E	23044EK	1470000	1880000	1200	1600
	340	90	3	23044A2X	23044A2XK	1460000	1860000	1800	2400
	340	118	3	24044E	24044EK30	1950000	2670000	1200	1500
	370	120	4	23144E	23144EK	2250000	2870000	1000	1300
	370	120	4	23144A2X	23144A2XK	2210000	2780000	1500	1800
	370	150	4	24144E	24144EK30	2530000	3250000	1100	1400
	400	108	4	22244E	22244EK	2140000	2380000	1200	1500
	400	144	4	23244E	23244EK	2920000	3500000	1000	1200
	460	145	5	22344E	22344EK	3350000	3600000	1000	1300

Note: Suffix K or K30 means tapered bore (1/12 or 1/30).

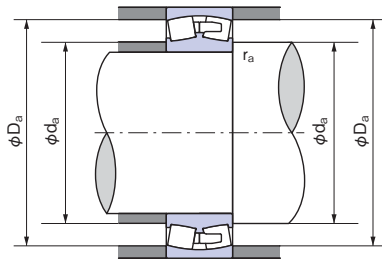

• Dynamic equivalent radial load
 $P_r = XFr + YFa$

$\frac{Fa}{Fr} \leq e$		$\frac{Fa}{Fr} > e$	
X	Y	X	Y
1	Y_1	0.67	Y_2

Values of Y_1 , Y_2 and e from table.

• Static equivalent radial load
 $P_0 = Fr + Y_0Fa$
 Values Y_0 from table.

Dimensions of lubrication holes and grooves			Abutment and fillet dimensions (mm)			Constant e	Axial load factor			Mass (kg) Cylindrical bore (Reference)	Bearing No.	
Hole diameter d_o	Groove width A	Hole count N	d_a (min)	D_a (max)	r_a (max)		Y_1	Y_2	Y_0		Cylindrical bore	Tapered bore
6	10	6	190.0	240.0	2.0	0.19	3.55	5.29	3.48	8.10	23936AX	23936AXK
8	15	6	192.0	268.0	2.0	0.24	2.84	4.23	2.78	17.4	23036E	23036EK
8	15	6	192.0	268.0	2.0	0.27	2.47	3.67	2.41	17.5	23036AX	23036AXK
8	16	6	192.0	268.0	2.0	0.33	2.04	3.03	1.99	22.7	24036EX1	24036EX1K
8	16	6	192.0	268.0	2.0	0.32	2.12	3.15	2.07	22.5	24036AX	24036AXK30
8	18	6	194.0	286.0	2.5	0.32	2.12	3.15	2.07	27.9	23136E	23136EK
8	18	6	194.0	286.0	2.5	0.33	2.04	3.04	2.00	28.2	23136A2X	23136A2XK
10	22	6	194.0	286.0	2.5	0.39	1.73	2.57	1.69	33.7	24136E	24136EK30
8	18	6	198.0	302.0	3.0	0.28	2.43	3.61	2.37	30.9	22236E	22236EK
10	22	6	198.0	302.0	3.0	0.36	1.87	2.79	1.83	39.4	23236E	23236EK
10	22	6	198.0	302.0	3.0	0.39	1.75	2.61	1.71	39.0	23236A2X	23236A2XK
12	26	6	198.0	362.0	3.0	0.36	1.87	2.78	1.83	70.5	22336E	22336EK
6	10	6	200.0	250.0	2.0	0.18	3.69	5.50	3.61	8.46	23938AX	23938AXK
6	14	6	202.0	278.0	2.0	0.25	2.69	4.00	2.63	18.4	23038E	23038EK
6	14	6	202.0	278.0	2.0	0.26	2.55	3.80	2.50	17.8	23038A2X	23038A2XK
8	18	6	202.0	278.0	2.0	0.34	1.98	2.94	1.93	24.6	24038E	24038EK30
10	22	6	204.0	306.0	2.5	0.32	2.09	3.11	2.04	35.0	23138E	23138EK
10	22	6	204.0	306.0	2.5	0.34	1.96	2.92	1.92	33.5	23138A2X	23138A2XK
12	26	6	204.0	306.0	2.5	0.40	1.68	2.50	1.64	42.0	24138E	24138EK30
8	18	6	208.0	322.0	3.0	0.28	2.39	3.56	2.34	37.2	22238E	22238EK
10	22	6	208.0	322.0	3.0	0.36	1.87	2.79	1.83	48.0	23238E	23238EK
10	22	6	208.0	322.0	3.0	0.39	1.72	2.59	1.68	47.5	23238A2X	23238A2XK
12	26	6	212.0	378.0	4.0	0.36	1.89	2.81	1.85	81.8	22338E	22338EK
6	11	6	212.0	268.0	2.0	0.20	3.44	5.13	3.37	11.9	23940AX	23940AXK
8	18	6	212.0	298.0	2.0	0.26	2.64	3.93	2.58	23.4	23040E	23040EK
8	18	6	212.0	298.0	2.0	0.28	2.45	3.64	2.39	23.3	23040A2X	23040A2XK
10	22	6	212.0	298.0	2.0	0.35	1.95	2.90	1.91	31.2	24040E	24040EK30
10	22	6	214.0	326.0	2.5	0.33	2.06	3.06	2.01	42.7	23140E	23140EK
10	22	6	214.0	326.0	2.5	0.35	1.94	2.83	1.89	42.5	23140A2X	23140A2XK
12	26	6	214.0	326.0	2.5	0.41	1.63	2.43	1.60	52.9	24140E	24140EK30
8	18	6	218.0	342.0	3.0	0.29	2.35	3.50	2.30	44.8	22240E	22240EK
12	26	6	218.0	342.0	3.0	0.37	1.85	2.75	1.80	57.7	23240E	23240EK
12	26	6	218.0	342.0	3.0	0.39	1.71	2.54	1.67	57.0	23240A2X	23240A2XK
12	26	6	222.0	398.0	4.0	0.35	1.93	2.87	1.88	93.7	22340E	22340EK
6	12	6	232.0	288.0	2.0	0.18	3.75	5.59	3.67	12.6	23944E	23944EK
8	18	6	234.0	326.0	2.5	0.26	2.64	3.39	2.58	30.7	23044E	23044EK
8	18	6	234.0	326.0	2.5	0.27	2.51	3.74	2.45	30.5	23044A2X	23044A2XK
10	22	6	234.0	326.0	2.5	0.34	1.98	2.95	1.94	40.3	24044E	24044EK30
10	22	6	238.0	352.0	3.0	0.33	2.06	3.07	2.02	54.3	23144E	23144EK
10	22	6	238.0	352.0	3.0	0.34	1.98	2.94	1.93	54.6	23144A2X	23144A2XK
12	26	6	238.0	352.0	3.0	0.41	1.66	2.47	1.62	66.3	24144E	24144EK30
10	22	6	238.0	382.0	3.0	0.29	2.36	3.52	2.31	61.9	22244E	22244EK
12	26	6	238.0	382.0	3.0	0.37	1.83	2.72	1.79	81.4	23244E	23244EK
12	26	6	242.0	438.0	4.0	0.34	2.00	2.98	1.95	119	22344E	22344EK

Spherical Roller Bearings

Bore Diameter : 240 ~ 340mm

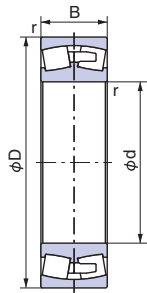

Cylindrical bore

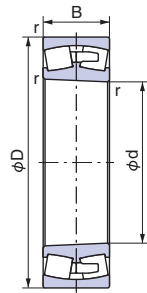

Tapered bore

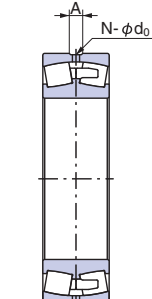

With oil holes / oil groove (W33)

1N=0.102kgf

d	Boundary dimensions (mm)			Bearing No.		Basic dynamic load rating Cr (N)	Basic static load rating Cor (N)	Limiting speed (min ⁻¹)	
	D	B	r (min)	Cylindrical bore	Tapered bore			Grease lubrication	Oil lubrication
240	320	60	2.1	23948E	23948EK	870000	1260000	1200	1600
	360	92	3	23048E	23048EK	1530000	2000000	1200	1500
	360	92	3	23048A2X	23048A2XK	1570000	2090000	1600	2200
	360	118	3	24048E	24048EK30	1990000	2800000	1000	1300
	400	128	4	23148E	23148EK	2610000	3350000	1000	1200
	400	128	4	23148A2X	23148A2XK	2540000	3250000	1300	1600
	400	160	4	24148E	24148EK30	2850000	3700000	1000	1200
	440	120	4	22248E	22248EK	2630000	2930000	1000	1300
	440	160	4	23248E	23248EK	3400000	4100000	945	1200
500	155	5	22348E	22348EK	3850000	4100000	1000	1200	
260	360	75	2.1	23952E	23952EK	1240000	1780000	1200	1500
	400	104	4	23052E	23052EK	1950000	2530000	1100	1400
	400	140	4	24052E	24052EK30	2630000	3700000	940	1200
	440	144	4	23152E	23152EK	3100000	4000000	900	1100
	440	180	4	24152E	24152EK30	3550000	4650000	900	1100
	480	130	5	22252E	22252EK	3100000	3500000	1000	1200
	480	174	5	23252E	23252EK	3950000	4800000	840	1000
540	165	6	22352E	22352EK	4350000	4750000	900	1100	
280	380	75	2.1	23956E	23956EK	1260000	1840000	1100	1400
	420	106	4	23056E	23056EK	2030000	2720000	1000	1300
	420	140	4	24056E	24056EK30	2680000	3900000	900	1100
	460	146	5	23156E	23156EK	3200000	4200000	840	1000
	460	180	5	24156E	24156EK30	3550000	4800000	840	1000
	500	130	5	22256E	22256EK	3200000	3700000	940	1200
	500	176	5	23256E	23256EK	4150000	5200000	790	1000
580	175	6	22356E	22356EK	4950000	5450000	840	1000	
300	420	90	3	23960E	23960EK	1740000	2520000	1000	1200
	460	118	4	23060E	23060EK	2500000	3300000	940	1200
	460	160	4	24060E	24060EK30	3350000	4850000	840	1000
	500	160	5	23160E	23160EK	3650000	4750000	790	1000
	500	200	5	24160E	24160EK30	4450000	6100000	790	1000
	540	140	5	22260E	22260EK	3700000	4300000	900	1100
	540	192	5	23260E	23260EK	4950000	6250000	720	900
620	185	7.5	22360E	22360EK	5500000	6050000	780	970	
320	440	90	3	23964E	23964EK	1770000	2610000	940	1200
	480	121	4	23064E	23064EK	2590000	3500000	900	1100
	480	160	4	24064E	24064EK30	3400000	5100000	790	1000
	540	176	5	23164E	23164EK	4350000	5700000	720	900
	540	218	5	24164E	24164EK30	5050000	6900000	720	900
	580	150	5	22264E	22264EK	4250000	4900000	820	1000
	580	208	5	23264E	23264EK	5600000	7200000	670	840
340	460	90	3	23968E	23968EK	1830000	2790000	900	1100
	520	133	5	23068E	23068EK	3150000	4300000	840	1000
	520	180	5	24068E	24068EK30	4100000	6050000	720	900
	580	190	5	23168E	23168EK	5150000	6750000	670	840
	580	243	5	24168E	24168EK30	6050000	8300000	670	840
	620	165	6	22268E	22268EK	5600000	6850000	750	930
620	224	6	23268E	23268EK	6300000	8000000	600	790	

Note: Suffix K or K30 means tapered bore (1/12 or 1/30).

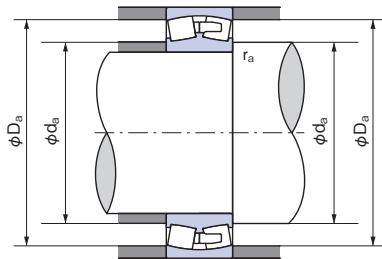

• Dynamic equivalent radial load
 $P_r = XFr + YFa$

$\frac{Fa}{Fr} \leq e$		$\frac{Fa}{Fr} > e$	
X	Y	X	Y
1	Y_1	0.67	Y_2

Values of Y_1 , Y_2 and e from table.

• Static equivalent radial load
 $P_0 = Fr + Y_0 Fa$

Values Y_0 from table.

Dimensions of lubrication holes and grooves			Abutment and fillet dimensions (mm)			Constant e	Axial load factor			Mass (kg) Cylindrical bore (Reference)	Bearing No.	
Hole diameter do	Groove width A	Hole count N	da (min)	Da (max)	ra (max)		Y_1	Y_2	Y_0		Cylindrical bore	Tapered bore
6	12	6	252.0	308.0	2.0	0.17	3.95	5.87	3.86	13.7	23948E	23948EK
8	18	6	254.0	346.0	2.5	0.24	2.76	4.11	2.70	33.5	23048E	23048EK
8	18	6	254.0	346.0	2.5	0.27	2.53	3.77	2.47	33.5	23048A2X	23048A2XK
10	22	6	254.0	346.0	2.5	0.32	2.10	3.13	2.05	43.3	24048E	24048EK30
12	26	6	258.0	382.0	3.0	0.32	2.13	3.17	2.08	66.6	23148E	23148EK
12	26	6	258.0	382.0	3.0	0.33	2.02	3.00	1.97	68.5	23148A2X	23148A2XK
12	26	6	258.0	382.0	3.0	0.40	1.69	2.51	1.65	81.6	24148E	24148EK30
10	22	6	258.0	422.0	3.0	0.28	2.37	3.53	2.32	82.8	22248E	22248EK
12	26	6	258.0	422.0	3.0	0.37	1.80	2.68	1.76	109	23248E	23248EK
12	26	6	262.0	487.0	4.0	0.34	2.00	2.98	1.96	151	22348E	22348EK
8	14	6	272.0	348.0	2.0	0.19	3.54	5.27	3.46	23.7	23952E	23952EK
10	22	6	278.0	382.0	3.0	0.25	2.66	3.97	2.61	48.9	23052E	23052EK
12	26	6	278.0	382.0	3.0	0.34	1.98	2.94	1.93	65.7	24052E	24052EK30
12	26	6	278.0	422.0	3.0	0.33	2.06	3.06	2.01	92.0	23152E	23152EK
15	32	6	278.0	422.0	3.0	0.42	1.59	2.37	1.56	113	24152E	24152EK30
12	26	6	282.0	458.0	4.0	0.28	2.40	3.57	2.34	107	22252E	22252EK
15	32	6	282.0	458.0	4.0	0.38	1.78	2.65	1.74	142	23252E	23252EK
15	32	8	288.0	512.0	5.0	0.33	2.04	3.03	1.99	187	22352E	22352EK
8	14	6	292.0	368.0	2.0	0.18	3.75	5.59	3.67	24.9	23956E	23956EK
10	22	6	298.0	402.0	3.0	0.24	2.79	4.15	2.73	52.7	23056E	23056EK
12	26	6	298.0	402.0	3.0	0.32	2.09	3.11	2.04	69.6	24056E	24056EK30
12	26	6	302.0	438.0	4.0	0.32	2.12	3.15	2.07	98.4	23156E	23156EK
15	32	6	302.0	438.0	4.0	0.39	1.74	2.59	1.70	120	24156E	24156EK30
12	26	6	302.0	478.0	4.0	0.27	2.53	3.77	2.47	113	22256E	22256EK
15	32	6	302.0	478.0	4.0	0.36	2.87	2.79	1.83	152	23256E	23256EK
15	32	8	308.0	552.0	5.0	0.33	2.07	3.09	2.03	228	22356E	22356EK
10	18	6	314.0	406.0	2.5	0.20	3.42	5.08	3.34	39.7	23960E	23960EK
10	22	6	318.0	442.0	3.0	0.25	2.71	4.04	2.65	72.8	23060E	23060EK
12	26	6	318.0	442.0	3.0	0.34	1.99	2.96	1.94	98.7	24060E	24060EK30
12	26	6	322.0	478.0	4.0	0.33	2.06	3.06	2.01	129	23160E	23160EK
15	32	6	322.0	478.0	4.0	0.40	1.68	2.50	1.64	160	24160E	24160EK30
12	26	8	322.0	518.0	4.0	0.27	2.49	3.71	2.43	144	22260E	22260EK
15	32	8	322.0	518.0	4.0	0.37	1.84	2.73	1.80	196	23260E	23260EK
15	32	8	336.0	584.0	6.0	0.32	2.09	3.11	2.04	279	22360E	22360EK
10	18	6	334.0	426.0	2.5	0.19	3.58	5.33	3.50	41.8	23964E	23964EK
12	26	6	338.0	462.0	3.0	0.24	2.76	4.11	2.70	78.6	23064E	23064EK
12	26	6	338.0	462.0	3.0	0.32	2.09	3.11	2.04	104	24064E	24064EK30
15	32	8	342.0	518.0	4.0	0.33	2.03	3.02	1.98	168	23164E	23164EK
15	35	4	342.0	518.0	4.0	0.41	1.65	2.46	1.61	206	24164E	24164EK30
12	26	8	342.0	558.0	4.0	0.27	2.51	3.73	2.45	179	22264E	22264EK
20	40	8	342.0	558.0	4.0	0.37	1.83	2.72	1.76	244	23264E	23264EK
10	18	6	354.0	446.0	2.5	0.18	3.80	5.66	3.72	44.1	23968E	23968EK
12	26	8	362.0	498.0	4.0	0.25	2.74	4.08	2.68	104	23068E	23068EK
15	32	8	362.0	498.0	4.0	0.34	1.98	2.94	1.93	141	24068E	24068EK30
15	32	8	362.0	558.0	4.0	0.33	2.03	3.02	1.98	212	23168E	23168EK
20	40	8	362.0	558.0	4.0	0.42	1.62	2.42	1.59	267	24168E	24168EK30
15	32	8	368.0	592.0	5.0	0.27	2.49	3.71	2.43	224	22268E	22268EK
20	40	8	368.0	592.0	5.0	0.37	1.82	2.70	1.78	299	23268E	23268EK

Spherical Roller Bearings

Bore Diameter : 360 ~ 500mm

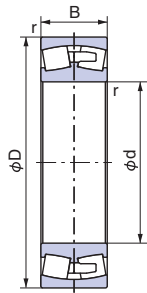

Cylindrical bore

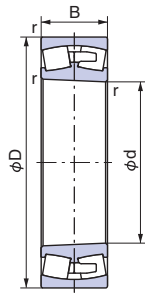

Tapered bore

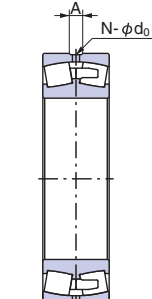

With oil holes / oil groove (W33)

1N=0.102kgf

Boundary dimensions (mm)				Bearing No.		Basic dynamic load rating Cr (N)	Basic static load rating Cor (N)	Limiting speed (min ⁻¹)	
d	D	B	r (min)	Cylindrical bore	Tapered bore			Grease lubrication	Oil lubrication
360	480	90	3	23972E	23972EK	1890000	2960000	900	1100
	540	134	5	23072E	23072EK	3200000	4500000	790	1000
	540	180	5	24072E	24072EK30	4250000	6350000	670	840
	600	192	5	23172E	23172EK	5350000	7250000	640	790
	600	243	5	24172E	24172EK30	6250000	8750000	640	790
	650	232	6	23272E	23272EK	6950000	9000000	570	750
380	520	106	4	23976E	23976EK	2390000	3650000	790	1000
	560	135	5	23076E	23076EK	3300000	4700000	750	940
	560	180	5	24076E	24076EK30	4300000	6650000	670	840
	620	194	5	23176E	23176EK	5400000	7400000	600	750
	620	243	5	24176E	24176EK30	6450000	9300000	600	750
	680	240	6	23276E	23276EK	7500000	9800000	540	720
400	540	106	4	23980E	23980EK	2470000	3900000	750	940
	600	148	5	23080E	23080EK	3900000	5500000	720	900
	600	200	5	24080E	24080EK30	5000000	7650000	600	750
	650	200	6	23180E	23180EK	5750000	7900000	570	720
	650	250	6	24180E	24180EK30	6900000	9850000	570	720
	720	256	6	23280E	23280EK	8500000	11100000	510	670
420	560	106	4	23984E	23984EK	2520000	4000000	720	900
	620	150	5	23084E	23084EK	4050000	5850000	670	840
	620	200	5	24084E	24084EK30	5150000	8000000	570	720
	700	224	6	23184E	23184EK	6800000	9250000	540	670
	700	280	6	24184E	24184EK30	8350000	12000000	540	670
	760	272	7.5	23284E	23284EK	9400000	12500000	490	640
440	600	118	4	23988E	23988EK	3100000	4900000	670	840
	650	157	6	23088E	23088EK	4300000	6250000	640	790
	650	212	6	24088E	24088EK30	5750000	9000000	540	670
	720	226	6	23188E	23188EK	7150000	10000000	510	640
	720	280	6	24188E	24188EK30	8550000	12700000	510	640
	790	280	7.5	23288E	23288EK	10000000	13300000	480	600
460	620	118	4	23992E	23992EK	3050000	4900000	640	790
	680	163	6	23092E	23092EK	4700000	6850000	600	750
	680	218	6	24092E	24092EK30	6100000	9650000	510	640
	760	240	7.5	23192E	23192EK	8000000	11200000	480	600
	760	300	7.5	24192E	24192EK30	9450000	13900000	480	600
	830	296	7.5	23292E	23292EK	10600000	14500000	450	570
480	650	128	5	23996E	23996EK	3300000	5450000	645	790
	700	165	6	23096E	23096EK	4850000	7250000	570	720
	700	218	6	24096E	24096EK30	6300000	10100000	510	640
	790	248	7.5	23196E	23196EK	8500000	12000000	450	570
	790	308	7.5	24196E	24196EK30	9950000	14800000	450	570
	870	310	7.5	23296E	23296EK	11300000	15400000	420	540
500	670	128	5	239/500E	239/500EK	3400000	5700000	600	750
	720	167	6	230/500E	230/500EK	5050000	7650000	570	720
	720	218	6	240/500E	240/500EK30	6450000	10500000	480	600
	830	264	7.5	231/500E	231/500EK	9300000	13000000	420	540
	830	325	7.5	241/500E	241/500EK30	11000000	16200000	420	540
	920	336	7.5	232/500E	232/500EK	13200000	17800000	390	510

Note: Suffix K or K30 means tapered bore (1/12 or 1/30).

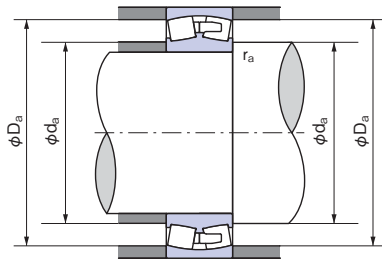

• Dynamic equivalent radial load
 $P_r = XFr + YFa$

$\frac{Fa}{Fr} \leq e$		$\frac{Fa}{Fr} > e$	
X	Y	X	Y
1	Y_1	0.67	Y_2

Values of Y_1 , Y_2 and e from table.

• Static equivalent radial load
 $P_0 = Fr + Y_0 Fa$

Values Y_0 from table.

Dimensions of lubrication holes and grooves			Abutment and fillet dimensions (mm)			Constant e	Axial load factor			Mass (kg) Cylindrical bore (Reference)	Bearing No.	
Hole diameter d_o	Groove width A	Hole count N	d_a (min)	D_a (max)	r_a (max)		Y_1	Y_2	Y_0		Cylindrical bore	Tapered bore
10	18	6	374.0	466.0	2.5	0.17	4.05	6.03	3.96	46.2	23972E	23972EK
12	26	8	382.0	518.0	4.0	0.24	2.84	4.23	2.78	110	23072E	23072EK
15	32	8	382.0	518.0	4.0	0.33	2.06	3.06	2.01	148	24072E	24072EK30
15	32	8	382.0	578.0	4.0	0.33	2.07	3.09	2.03	225	23172E	23172EK
20	40	8	382.0	578.0	4.0	0.42	1.60	2.39	1.57	279	24172E	24172EK30
20	40	8	388.0	622.0	5.0	0.37	1.82	2.70	1.78	342	23272E	23272EK
12	24	8	398.0	502.0	3.0	0.19	3.58	5.33	3.50	68.2	23976E	23976EK
12	26	8	402.0	538.0	4.0	0.23	2.92	4.35	2.86	116	23076E	23076EK
15	32	8	402.0	538.0	4.0	0.31	2.15	3.20	2.10	154	24076E	24076EK30
15	32	8	402.0	598.0	4.0	0.32	2.13	3.17	2.08	236	23176E	23176EK
20	40	8	402.0	598.0	4.0	0.40	1.70	2.53	1.66	290	24176E	24176EK30
20	40	8	408.0	652.0	5.0	0.36	1.86	2.77	1.82	383	23276E	23276EK
12	24	8	418.0	522.0	3.0	0.18	3.75	5.59	3.67	71.4	23980E	23980EK
12	26	8	422.0	578.0	4.0	0.24	2.81	4.19	2.75	151	23080E	23080EK
15	32	8	422.0	578.0	4.0	0.33	2.03	3.02	1.98	204	24080E	24080EK30
15	32	8	428.0	622.0	5.0	0.31	2.18	3.24	2.13	266	23180E	23180EK
20	40	8	428.0	622.0	5.0	0.39	1.73	2.57	1.69	330	24180E	24180EK30
20	45	8	428.0	692.0	5.0	0.36	1.86	2.77	1.82	461	23280E	23280EK
12	24	8	438.0	542.0	3.0	0.18	3.85	5.73	3.76	74.4	23984E	23984EK
12	26	8	442.0	598.0	4.0	0.23	2.92	4.35	2.86	158	23084E	23084EK
15	32	8	442.0	598.0	4.0	0.32	2.09	3.11	2.04	212	24084E	24084EK30
20	40	8	448.0	672.0	5.0	0.33	2.06	3.06	2.01	354	23184E	23184EK
20	45	8	448.0	672.0	5.0	0.40	1.68	2.50	1.64	437	24184E	24184EK30
20	45	8	456.0	724.0	6.0	0.37	1.84	2.74	1.80	548	23284E	23284EK
12	24	8	458.0	582.0	3.0	0.18	3.66	5.46	3.58	101	23988E	23988EK
12	26	8	468.0	622.0	5.0	0.24	2.87	4.27	2.80	183	23088E	23088EK
20	40	8	468.0	622.0	5.0	0.32	2.09	3.11	2.04	247	24088E	24088EK30
20	40	8	468.0	692.0	5.0	0.32	2.13	3.17	2.08	371	23188E	23188EK
20	45	8	468.0	692.0	5.0	0.39	1.73	2.58	1.69	460	24188E	24188EK30
20	45	8	476.0	754.0	6.0	0.36	1.86	2.77	1.82	605	23288E	23288EK
12	24	8	478.0	602.0	3.0	0.18	3.85	5.73	3.76	105	23992E	23992EK
15	32	8	488.0	652.0	5.0	0.23	2.92	4.35	2.86	208	23092E	23092EK
20	40	8	488.0	652.0	5.0	0.32	2.12	3.15	2.07	279	24092E	24092EK30
20	40	8	496.0	724.0	6.0	0.32	2.12	3.15	2.07	446	23192E	23192EK
20	45	8	496.0	724.0	6.0	0.40	1.69	2.52	1.65	550	24192E	24192EK30
20	45	8	496.0	794.0	6.0	0.36	1.85	2.75	1.81	709	23292E	23292EK
15	32	8	502.0	628.0	4.0	0.18	3.75	5.59	3.67	126	23996E	23996EK
15	32	8	508.0	672.0	5.0	0.22	3.01	4.48	2.94	217	23096E	23096EK
20	40	8	508.0	672.0	5.0	0.31	2.20	3.27	2.15	290	24096E	24096EK30
20	40	8	516.0	754.0	6.0	0.32	2.12	3.15	2.07	495	23196E	23196EK
20	45	8	516.0	754.0	6.0	0.39	1.71	2.54	1.67	625	24196E	24196EK30
20	45	8	516.0	834.0	6.0	0.37	1.82	2.70	1.78	820	23296E	23296EK
15	28	8	522.0	648.0	4.0	0.18	3.85	5.73	3.76	130	239/500E	239/500EK
15	32	8	528.0	692.0	5.0	0.22	3.07	4.57	3.00	228	230/500E	230/500EK
20	40	8	528.0	692.0	5.0	0.30	2.26	3.37	2.21	300	240/500E	240/500EK30
20	45	8	536.0	794.0	6.0	0.32	2.09	3.11	2.04	584	231/500E	231/500EK
25	50	8	536.0	794.0	6.0	0.40	1.70	2.53	1.66	718	241/500E	241/500EK30
25	50	8	536.0	884.0	6.0	0.38	1.78	2.65	1.74	1000	232/500E	232/500EK

Spherical Roller Bearings

Bore Diameter : 530 ~ 1060mm

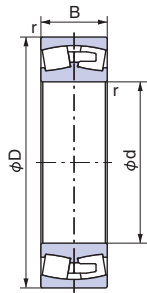

Cylindrical bore

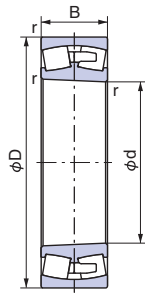

Tapered bore

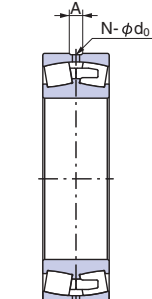

With oil holes / oil groove (W33)

1N=0.102kgf

Boundary dimensions (mm)				Bearing No.		Basic dynamic load rating Cr (N)	Basic static load rating Cor (N)	Limiting speed (min ⁻¹)	
d	D	B	r (min)	Cylindrical bore	Tapered bore			Grease lubrication	Oil lubrication
530	710	136	5	239/530E	239/530EK	4100000	6800000	540	670
	780	185	6	230/530E	230/530EK	6250000	9450000	550	670
	780	250	6	240/530E	240/530EK30	7800000	12500000	450	550
	870	272	7.5	231/530E	231/530EK	10200000	14600000	390	510
	980	355	9.5	232/530E	232/530EK	15300000	21000000	330	450
560	750	140	5	239/560E	239/560EK	4250000	6950000	510	640
	820	195	6	230/560E	230/560EK	7000000	10800000	510	640
	820	258	6	240/560E	240/560EK30	8350000	13500000	420	520
	920	280	7.5	231/560E	231/560EK	11000000	15800000	360	480
	1030	365	9.5	232/560E	232/560EK	16000000	22000000	280	400
600	800	150	5	239/600E	239/600EK	4800000	8050000	480	600
	870	200	6	230/600E	230/600EK	7650000	12000000	480	600
	870	272	6	240/600E	240/600EK30	9050000	14900000	390	490
	980	300	7.5	231/600E	231/600EK	12100000	17500000	300	420
	1090	388	9.5	232/600E	232/600EK	17900000	25100000	240	360
630	850	165	6	239/630E	239/630EK	5750000	9700000	420	540
	920	212	7.5	230/630E	230/630EK	8350000	13100000	430	570
	1030	315	7.5	231/630E	231/630EK	13500000	19800000	280	390
670	900	170	6	239/670E	239/670EK	6200000	10500000	390	510
	980	230	7.5	230/670E	230/670EK	9650000	15300000	400	510
	980	308	7.5	240/670E	240/670EK30	12000000	19800000	340	430
	1090	336	7.5	231/670E	231/670EK	15300000	23000000	270	360
	950	180	6	239/710E	239/710EK	6950000	12100000	360	480
710	1030	236	7.5	230/710E	230/710EK	10300000	16600000	370	480
	1150	345	9.5	231/710E	231/710EK	16800000	25300000	250	330
	1000	185	6	239/750E	239/750EK	7500000	13200000	330	450
750	1090	250	7.5	230/750E	230/750EK	11700000	18900000	340	450
	1220	365	9.5	231/750E	231/750EK	18100000	27700000	220	280
	1060	195	6	239/800E	239/800EK	8150000	14500000	300	420
800	1150	258	7.5	230/800E	230/800EK	12200000	20900000	310	400
	1150	345	7.5	240/800E	240/800EK30	15400000	27200000	300	370
	1280	375	9.5	231/800E	231/800EK	20000000	31000000	240	310
850	1120	200	6	239/850E	239/850EK	8600000	15600000	280	390
	1220	272	7.5	230/850E	230/850EK	13600000	22500000	285	360
900	1180	206	6	239/900E	239/900EK	9300000	17000000	270	360
	1280	280	7.5	230/900E	230/900EK	14600000	25400000	270	330
950	1250	224	7.5	239/950E	239/950EK	10800000	19900000	250	330
	1360	300	7.5	230/950E	230/950EK	16100000	27200000	240	300
1000	1320	236	7.5	239/1000E	239/1000EK	11600000	21300000	220	300
	1420	308	7.5	230/1000E	230/1000EK	17200000	29700000	220	280
1060	1400	250	7.5	239/1060E	239/1060EK	13200000	24500000	210	270

Note: Suffix K or K30 means tapered bore (1/12 or 1/30).

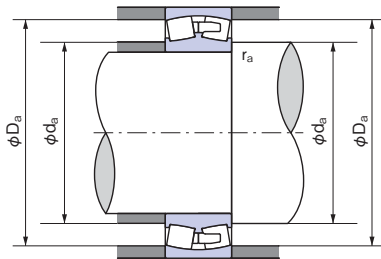

• Dynamic equivalent radial load
 $P_r = XFr + YFa$

$\frac{Fa}{Fr} \leq e$		$\frac{Fa}{Fr} > e$	
X	Y	X	Y
1	Y_1	0.67	Y_2

Values of Y_1 , Y_2 and e from table.

• Static equivalent radial load
 $P_{0r} = Fr + Y_0Fa$

Values Y_0 from table.

Dimensions of lubrication holes and grooves			Abutment and fillet dimensions (mm)			Constant e	Axial load factor			Mass (kg) Cylindrical bore (Reference)	Bearing No.	
Hole diameter d_o	Groove width A	Hole count N	d_a (min)	D_a (max)	r_a (max)		Y_1	Y_2	Y_0		Cylindrical bore	Tapered bore
15	28	8	552.0	688.0	4.0	0.18	3.85	5.73	3.76	156	239/530E	239/530EK
15	32	8	558.0	752.0	5.0	0.23	2.98	4.44	2.91	308	230/530E	230/530EK
20	40	8	558.0	752.0	5.0	0.32	2.12	3.15	2.07	417	240/530E	240/530EK30
20	45	8	566.0	834.0	6.0	0.32	2.13	3.17	2.08	640	231/530E	231/530EK
25	60	8	574.0	936.0	8.0	0.37	1.80	2.69	1.76	1215	232/530E	232/530EK
15	28	8	582.0	728.0	4.0	0.17	3.90	5.80	3.81	177	239/560E	239/560EK
15	32	8	588.0	792.0	5.0	0.23	2.95	4.39	2.89	359	230/560E	230/560EK
20	45	8	588.0	792.0	5.0	0.31	2.21	3.29	2.16	468	240/560E	240/560EK30
20	45	8	596.0	884.0	6.0	0.31	2.20	3.27	2.15	732	231/560E	231/560EK
25	50	8	612.0	992.0	8.0	0.37	1.82	2.70	1.78	1390	232/560E	232/560EK
20	35	8	622.0	778.0	4.0	0.17	3.95	5.87	3.86	214	239/600E	239/600EK
15	32	8	628.0	842.0	5.0	0.22	3.10	4.62	3.03	408	230/600E	230/600EK
20	45	8	628.0	842.0	5.0	0.31	2.20	3.27	2.15	551	240/600E	240/600EK30
20	45	8	636.0	944.0	6.0	0.31	2.20	3.27	2.15	887	231/600E	231/600EK
25	50	8	654.0	1048	8.0	0.37	1.82	2.70	1.78	1640	232/600E	232/600EK
20	35	8	658.0	822.0	5.0	0.18	3.71	5.52	3.62	273	239/630E	239/630EK
20	40	8	666.0	884.0	6.0	0.22	3.07	4.57	3.00	487	230/630E	230/630EK
20	45	8	666.0	994.0	6.0	0.31	2.20	3.27	2.15	1070	231/630E	231/630EK
20	35	8	698.0	872.0	5.0	0.17	3.90	5.80	3.81	316	239/670E	239/670EK
20	40	8	706.0	944.0	6.0	0.22	3.01	4.48	2.94	603	230/670E	230/670EK
20	45	8	706.0	944.0	6.0	0.31	2.21	3.29	2.16	801	240/670E	240/670EK30
25	50	8	706.0	1054	6.0	0.31	2.18	3.24	2.13	1260	231/670E	231/670EK
20	35	8	738.0	922.0	5.0	0.17	3.90	5.80	3.81	369	239/710E	239/710EK
20	40	8	746.0	994.0	6.0	0.22	3.10	4.62	3.03	676	230/710E	230/710EK
25	50	8	754.0	1106	8.0	0.30	2.24	3.34	2.19	1432	231/710E	231/710EK
20	35	8	778.0	972.0	5.0	0.17	4.00	5.95	3.91	417	239/750E	239/750EK
20	40	8	786.0	1054	6.0	0.22	3.10	4.62	3.03	803	230/750E	230/750EK
25	50	8	794.0	1176	8.0	0.30	2.25	3.34	2.20	1710	231/750E	231/750EK
20	35	8	825.0	1032	5.0	0.17	4.00	5.96	3.91	470	239/800E	239/800EK
20	45	8	836.0	1114	6.0	0.21	3.20	4.77	3.13	910	230/800E	230/800EK
25	50	8	836.0	1114	6.0	0.28	2.43	3.61	2.37	1200	240/800E	240/800EK30
25	50	8	844.0	1236	8.0	0.29	2.32	3.45	2.26	1910	231/800E	231/800EK
20	40	8	878.0	1092	5.0	0.16	4.16	6.20	4.07	546	239/850E	239/850EK
20	40	8	886.0	1184	6.0	0.21	3.20	4.77	3.13	1059	230/850E	230/850EK
20	40	8	928.0	1152	5.0	0.16	4.22	6.28	4.13	618	239/900E	239/900EK
20	45	8	936.0	1244	6.0	0.21	3.27	4.87	3.20	1200	230/900E	230/900EK
20	40	8	986.0	1214	6.0	0.16	4.11	6.12	4.02	763	239/950E	239/950EK
20	45	8	986.0	1324	6.0	0.21	3.23	4.82	3.16	1450	230/950E	230/950EK
25	48	8	1036	1284	6.0	0.17	4.05	6.03	3.96	895	239/1000E	239/1000EK
20	45	8	1036	1384	6.0	0.21	3.27	4.87	3.20	1610	230/1000E	230/1000EK
25	48	8	1096	1364	6.0	0.17	4.05	6.03	3.96	1077	239/1060E	239/1060EK



Spherical Roller Thrust Bearings

Aligning angle

Maximum permissible misalignment angle is about 2° under general service conditions. If the aligning advantages of this bearing type are to be realized, care must be taken to provide clearance for parts in the surrounding structure.

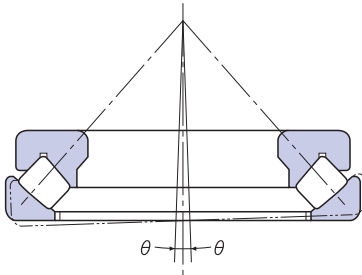

Minimum axial load

To prevent damage caused by sliding motion between the rollers and raceway, spherical roller thrust bearings must be subjected to a load more than the minimum load, $F_{a \min}$.

$$F_{a \min} = \frac{C_{0a}}{1000}$$

Lubrication

Because there are many sliding surfaces in E type Spherical Roller Thrust Bearings (cage-to-guide-sleeve and roller-ends-to-rib), oil lubricant (not grease) should be applied.

Safety-factor

The safety-factor "So" must be over 4.

Tolerance Values of Spherical Roller Thrust Bearings (Class 0)

Tolerance Values of Inner Rings

Unit: μm

Nominal bearing bore diameter d (mm)		Single plane mean bore diameter deviation Δd_{mp}		Bore diameter variation, in a single radial plane Vd_p	References			
					Inner ring reference face runout with bore S_d		Deviation of single height, ΔI_s	
Over	Incl.	High	Low	High	Low	High	Low	
50	80	0	-15	11	25	+150	-150	
80	120	0	-20	15	25	+200	-200	
120	180	0	-25	19	30	+250	-250	
180	250	0	-30	23	30	+300	-300	
250	315	0	-35	26	35	+350	-350	
315	400	0	-40	30	40	+400	-400	
400	500	0	-45	34	45	+450	-450	

Tolerance Values of Outer Rings

Unit: μm

Nominal bearing outside diameter D (mm)		Outside diameter deviation ΔD_{mp}	
		High	Low
Over	Incl.	High	Low
120	180	0	-25
180	250	0	-30
250	315	0	-35
315	400	0	-40
400	500	0	-45
500	630	0	-50
630	800	0	-75
800	1000	0	-100

Remarks: The high deviation of bearing bore diameter specified in this table does not apply within a distance of $1.2 \times r$ (max) from the ring face.
The low deviation of bearing outside diameter specified in this table does not apply within a distance of $1.2 \times r$ (max) from the ring face.

Spherical Roller Thrust Bearings

Bore Diameter : 60 ~ 180mm

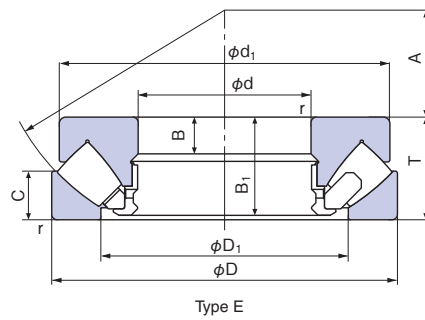
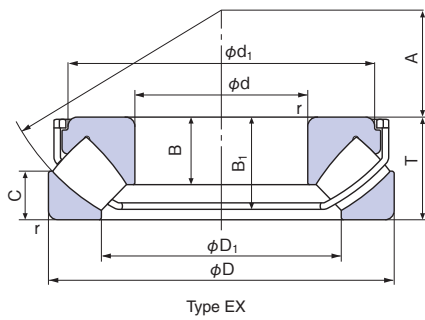

1N=0.102kgf

Boundary dimensions (mm)				Bearing No.	Basic dynamic load rating Ca (N)	Basic static load rating Coa (N)	Limiting speed (min ⁻¹)	
d	D	T	r (min)				Grease lubrication	Oil lubrication
60	130	42	1.5	29412E	299000	890000	—	2800
	130	42	1.5	29412EX	350000	915000	1800	2800
65	140	45	2	29413E	345000	1040000	—	2700
	140	45	2	29413EX	410000	1110000	1700	2700
70	150	48	2	29414E	375000	1110000	—	2400
	150	48	2	29414EX	490000	1350000	1600	2400
75	160	51	2	29415E	445000	1380000	—	2300
	160	51	2	29415EX	525000	1470000	1600	2300
80	170	54	2.1	29416E	480000	1490000	—	2100
	170	54	2.1	29416EX	580000	1630000	1500	2100
85	150	39	1.5	29317E	293000	990000	—	2700
	150	39	1.5	29317EX	365000	1060000	1600	2700
	180	58	2.1	29417E	540000	1720000	—	2000
90	180	58	2.1	29417EX	640000	1810000	1300	2000
	155	39	1.5	29318E	300000	1040000	—	2700
	155	39	1.5	29318EX	355000	1070000	1600	2700
100	190	60	2.1	29418E	620000	2020000	—	1900
	190	60	2.1	29418EX	710000	2080000	1300	1900
	170	42	1.5	29320E	355000	1260000	—	2500
110	170	42	1.5	29320EX	435000	1400000	1500	2500
	210	67	3	29420E	690000	2230000	—	1700
	210	67	3	29420EX	870000	2530000	1100	1700
120	190	48	2	29322E	470000	1680000	—	2100
	190	48	2	29322EX	550000	1730000	1300	2100
	230	73	3	29422E	845000	2820000	—	1500
130	230	73	3	29422EX	1060000	3150000	950	1500
	210	54	2.1	29324E	565000	2030000	—	1900
	210	54	2.1	29324EX	670000	2160000	1100	1900
140	250	78	4	29424E	1030000	3450000	—	1400
	250	78	4	29424EX	1210000	3750000	900	1400
	225	58	2.1	29326E	665000	2420000	—	1800
150	225	58	2.1	29326EX	770000	2440000	1000	1800
	270	85	4	29426E	1140000	3850000	—	1200
	270	85	4	29426EX	1400000	4300000	850	1200
160	240	60	2.1	29328E	700000	2560000	—	1600
	240	60	2.1	29328EX	860000	2840000	950	1600
	280	85	4	29428E	1200000	4050000	—	1200
170	280	85	4	29428EX	1410000	4350000	850	1200
	215	39	1.5	29230E	335000	1390000	—	2100
	250	60	2.1	29330E	735000	2840000	—	1600
180	300	90	4	29430E	1330000	4600000	—	1100
	300	90	4	29430EX	1630000	5150000	800	1100
	225	39	1.5	29232E	345000	1470000	—	2100
190	270	67	3	29332E	880000	3400000	—	1400
	270	67	3	29332EX	1040000	3500000	850	1400
	320	95	5	29432E	1510000	5350000	—	1000
200	320	95	5	29432EX	1820000	5750000	750	1000
	240	42	1.5	29234E	390000	1700000	—	1900
	280	67	3	29334E	900000	3550000	—	1400
210	340	103	5	29434E	1670000	5900000	—	950
	250	42	1.5	29236E	420000	1900000	—	1900
	300	73	3	29336E	1020000	3950000	—	1300
220	360	109	5	29436E	1950000	7000000	—	860

Note: For heavy load application, d₁ should be large enough to support the shaft washer rib.

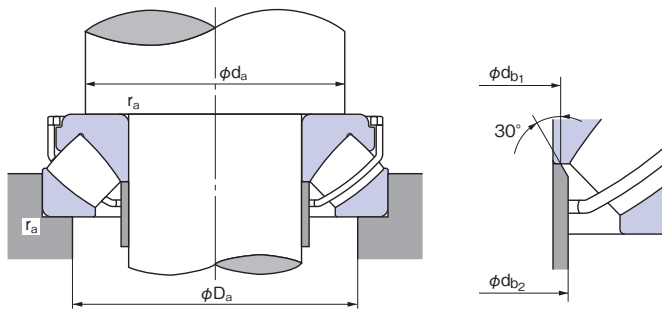

- Dynamic equivalent axial load
 $P_a = F_a + 1.2F_r$
 - Static equivalent axial load
 $P_{0a} = F_a + 2.7F_r$
- where, F_a : Axial load
 F_r : Radial load
- However $F_r/F_a \leq 0.55$ must be satisfied

Reference Dimensions (mm)						Abutment and fillet dimensions (mm)			Spacer dimensions (mm)		Mass (kg) (Reference)	Bearing No.
d_i	D_i	B	B_1	C	A	d_a (min)	D_a (max)	r_a (max)	d_{b1} (max)	d_{b2} (max)		
123	89	15	39.5	20	38	91	108	1.5	—	—	2.75	29412E
113	87	27	37.1	20	38	91	108	1.5	66.0	66.0	2.50	29412EX
133	96	16	42.5	21	42	99	115	2.0	—	—	3.41	29413E
123	93.5	29.5	40	21	42	99	115	2.0	72.0	72.0	3.20	29413EX
142	103	17	45.5	23	44	106	125	2.0	—	—	4.16	29414E
128.3	98.4	32	42.7	23	44	106	125	2.0	75.5	77.5	3.82	29414EX
152	109	18	48	24	47	113	132	2.0	—	—	4.98	29415E
140	105.6	34.5	45.6	24	47	113	132	2.0	82.5	82.5	4.70	29415EX
162	117	19	51	26	50	120	140	2.0	—	—	5.95	29416E
149	113	36	48.2	26	50	120	140	2.0	88.0	88.0	5.60	29416EX
143.5	114	13	37	19	50	115	135	1.5	—	—	2.87	29317E
134	110.5	25	35	19	50	115	135	1.5	90.0	90.0	2.67	29317EX
170	125	21	55	28	54	130	150	2.0	—	—	7.19	29417E
158.2	120.5	37	50.6	28	54	130	150	2.0	94.0	94.0	6.69	29417EX
148.5	117	13	37	19	52	120	140	1.5	—	—	3.06	29318E
135.2	116	23.8	35.1	19	52	120	140	1.5	95.0	95.0	2.75	29318EX
180	132	22	57	29	56	135	157	2.0	—	—	8.28	29418E
162	127	40.5	53	29	56	135	157	2.0	99.0	99.0	7.83	29418EX
163	129	14	40	20.8	58	130	150	1.5	—	—	3.91	29320E
146.9	126	27	38.2	20.8	58	130	150	1.5	105.0	107.0	3.61	29320EX
200	146	24	64	32	62	150	175	2.5	—	—	11.2	29420E
181	139	44.5	59.6	32	62	150	175	2.5	108.0	110.0	10.6	29420EX
182	143	16	45.5	23	64	145	165	2.0	—	—	5.67	29322E
165.1	140.6	30.9	44	23	64	145	165	2.0	116.0	117.0	5.22	29322EX
220	162	26	69	35	69	165	190	2.5	—	—	14.7	29422E
199.6	153.4	48	64.4	35	69	165	190	2.5	119.5	120.0	14.0	29422EX
200	159	18	51	26	70	160	180	2.0	—	—	7.90	29324E
184.5	155	34.5	48.7	26	70	160	180	2.0	127.0	128.0	7.30	29324EX
236	174	29	74	37	74	180	205	3.0	—	—	18.5	29424E
218	166.5	54	70.9	37	74	180	205	3.0	131.0	132.0	17.6	29424EX
215	171	19	55	28	76	170	195	2.0	—	—	9.45	29326E
197.4	165.8	36.8	52.7	28	76	170	195	2.0	136.0	138.0	8.82	29326EX
255	189	31	81	41	81	195	225	3.0	—	—	23.5	29426E
236.4	181	56	75	41	81	195	225	3.0	141.5	143.0	22.3	29426EX
230	183	20	57	29	82	185	205	2.0	—	—	11.2	29328E
218.4	179	38.5	54.8	29	82	185	205	2.0	147.5	149.0	10.5	29328EX
268	199	31	81	41	86	205	235	3.0	—	—	24.6	29428E
246	196	53.6	74.4	41	86	205	235	3.0	153.0	160.0	22.8	29428EX
208	178	14	37	19	82	179	196	1.5	—	—	4.60	29230E
240	194	20	57	29	87	195	215	2.0	—	—	11.7	29330E
285	214	32	86	44	92	220	250	3.0	—	—	29.6	29430E
264.4	207.5	58.5	80.8	44	92	220	250	3.0	163.0	169.0	27.8	29430EX
219	188	14	37	19	85	189	206	1.5	—	—	4.70	29232E
260	208	23	64	32	92	210	235	2.5	—	—	15.5	29332E
243.4	199.8	44	61.4	32	92	210	235	2.5	166.0	174.0	14.5	29332EX
306	229	34	91	45	99	230	265	4.0	—	—	35.9	29432E
283.8	222	62.5	85.7	45	99	230	265	4.0	174.5	181.0	33.4	29432EX
233	198	15	40	20	92	201	218	1.5	—	—	6.00	29234E
270	216	23	64	32	96	220	245	2.5	—	—	16.3	29334E
324	243	37	99	50	104	245	285	4.0	—	—	44.0	29434E
243	208	15	40	21	95	211	228	1.5	—	—	6.30	29236E
290	232	25	69	35	103	235	260	2.5	—	—	20.7	29336E
342	255	39	105	52	110	260	300	4.0	—	—	52.2	29436E

Spherical Roller Thrust Bearings

Bore Diameter : 190 ~ 530mm

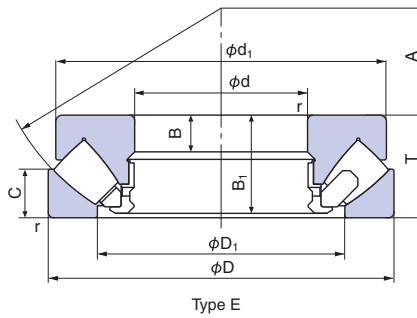

1N=0.102kgf

Boundary dimensions (mm)				Bearing No.	Basic dynamic load rating Ca (N)	Basic static load rating Coa (N)	Limiting speed (min ⁻¹)	
d	D	T	r (min)				Grease lubrication	Oil lubrication
190	270	48	2	29238E	540000	2300000	—	1800
	320	78	4	29338E	1170000	4550000	—	1100
	380	115	5	29438E	2120000	7750000	—	800
200	280	48	2	29240E	550000	2410000	—	1800
	340	85	4	29340E	1350000	5250000	—	1000
	400	122	5	29440E	2350000	8450000	—	740
220	300	48	2	29244E	595000	2750000	—	1600
	360	85	4	29344E	1410000	5750000	—	1000
	420	122	6	29444E	2410000	8950000	—	720
240	340	60	2.1	29248E	890000	4000000	—	1300
	380	85	4	29348E	1410000	5850000	—	980
	440	122	6	29448E	2480000	9450000	—	720
260	360	60	2.1	29252E	915000	4250000	—	1300
	420	95	5	29352E	1810000	7500000	—	860
	480	132	6	29452E	2940000	11600000	—	640
280	380	60	2.1	29256E	935000	4500000	—	1200
	440	95	5	29356E	1850000	7950000	—	840
	520	145	6	29456E	3450000	13500000	—	580
300	420	73	3	29260E	1220000	5850000	—	1000
	480	109	5	29360E	2310000	10000000	—	720
	540	145	6	29460E	3650000	14800000	—	540
320	440	73	3	29264E	1270000	6150000	—	980
	500	109	5	29364E	2370000	10600000	—	720
	580	155	7.5	29464E	4050000	16800000	—	480
340	460	73	3	29268E	1290000	6350000	—	950
	540	122	5	29368E	2850000	12400000	—	630
	620	170	7.5	29468E	4750000	19300000	—	430
360	500	85	4	29272E	1650000	8050000	—	830
	560	122	5	29372E	2900000	12900000	—	600
	640	170	7.5	29472E	4900000	20500000	—	410
380	520	85	4	29276E	1780000	8800000	—	800
	600	132	6	29376E	3400000	15300000	—	540
	670	175	7.5	29476E	5200000	22000000	—	400
400	540	85	4	29280E	1840000	9250000	—	800
	620	132	6	29380E	3550000	16300000	—	530
	710	185	7.5	29480E	5850000	25000000	—	360
420	580	95	5	29284E	2260000	11300000	—	700
	650	140	6	29384E	3900000	17900000	—	480
	730	185	7.5	29484E	6050000	26000000	—	360
440	600	95	5	29288E	2290000	11800000	—	660
	680	145	6	29388E	4050000	19000000	—	450
	780	206	9.5	29488E	6950000	30000000	—	300
460	620	95	5	29292E	2290000	11900000	—	660
	710	150	6	29392E	4600000	21700000	—	430
	800	206	9.5	29492E	7150000	31500000	—	290
480	650	103	5	29296E	2530000	13200000	—	600
	730	150	6	29396E	4630000	21900000	—	410
	850	224	9.5	29496E	8250000	36000000	—	260
500	670	103	5	292/500E	2590000	13800000	—	600
	750	150	6	293/500E	4700000	22600000	—	410
	870	224	9.5	294/500E	8250000	35000000	—	250
530	710	109	5	292/530E	2820000	15100000	—	540

Note: For heavy load application, d_s should be large enough to support the shaft washer rib.

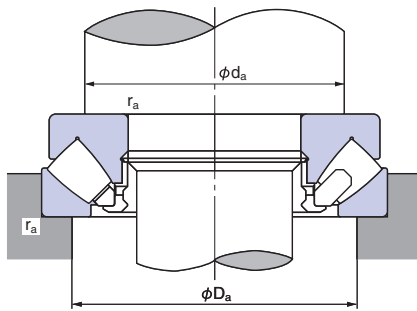

- Dynamic equivalent axial load
 $P_a = F_a + 1.2F_r$
 - Static equivalent axial load
 $P_{0a} = F_a + 2.7F_r$
- where, F_a : Axial load
 F_r : Radial load
- However $F_r/F_a \leq 0.55$ must be satisfied

Reference Dimensions (mm)						Abutment and fillet dimensions (mm)			Spacer dimensions (mm)		Mass (kg) (Reference)	Bearing No.
d_i	D_i	B	B_1	C	A	d_a (min)	D_a (max)	r_a (max)	db_1 (max)	db_2 (max)		
262	223	15	45	24	104	225	245	2.0	—	—	8.50	29238E
308	246	27	74	38	110	250	275	3.0	—	—	25.5	29338E
360	271	41	111	55	117	275	320	4.0	—	—	61.4	29438E
271	236	15	45	24	108	235	255	2.0	—	—	9.08	29240E
325	261	29	81	41	116	265	295	3.0	—	—	32.0	29340E
380	286	43	117	59	122	290	335	4.0	—	—	73.0	29440E
292	254	15	45	24	117	260	275	2.0	—	—	9.84	29244E
345	280	29	81	41	125	285	315	3.0	—	—	34.5	29344E
400	308	43	117	58	132	310	355	5.0	—	—	74.2	29444E
330	283	19	57	30	130	285	305	2.0	—	—	17.1	29248E
365	300	29	81	41	135	300	330	3.0	—	—	36.3	29348E
420	326	43	117	59	142	330	375	5.0	—	—	83.0	29448E
350	302	19	57	30	139	305	325	2.0	—	—	18.5	29252E
405	329	32	91	45	148	330	365	4.0	—	—	51.5	29352E
460	357	48	127	64	154	360	405	5.0	—	—	106	29452E
370	323	19	57	30	150	325	345	2.0	—	—	19.5	29256E
423	348	32	91	46	158	350	390	4.0	—	—	54.0	29356E
495	387	52	140	68	166	390	440	5.0	—	—	137	29456E
405	353	21	69	38	162	355	380	2.5	—	—	31.0	29260E
460	379	37	105	50	168	380	420	4.0	—	—	75.4	29360E
515	402	52	140	70	175	410	460	5.0	—	—	146	29460E
430	372	21	69	38	172	375	400	2.5	—	—	32.8	29264E
482	399	37	105	53	180	400	440	4.0	—	—	80.0	29364E
555	435	55	149	75	191	435	495	6.0	—	—	179	29464E
445	395	21	69	37	183	395	420	2.5	—	—	34.5	29268E
520	428	41	117	59	192	430	470	4.0	—	—	106	29368E
590	462	61	164	82	201	465	530	6.0	—	—	228	29468E
485	423	25	81	44	194	420	455	3.0	—	—	50.4	29272E
540	448	41	117	59	202	450	495	4.0	—	—	111	29372E
610	480	61	164	82	210	485	550	6.0	—	—	234	29472E
505	441	27	81	42	202	440	475	3.0	—	—	52.8	29276E
580	477	44	127	63	216	480	525	5.0	—	—	140	29376E
640	504	63	168	85	230	510	575	6.0	—	—	263	29476E
526	460	27	81	42	212	460	490	3.0	—	—	55.1	29280E
596	494	44	127	64	225	500	550	5.0	—	—	146	29380E
680	534	67	178	89	236	540	610	6.0	—	—	314	29480E
564	489	30	91	46	225	490	525	4.0	—	—	74.9	29284E
626	520	48	135	68	235	525	575	5.0	—	—	170	29384E
700	556	67	178	89	244	560	630	6.0	—	—	325	29484E
585	508	30	91	49	235	510	545	4.0	—	—	79.0	29288E
655	548	49	140	70	245	550	600	5.0	—	—	192	29388E
745	588	74	199	100	260	595	670	8.0	—	—	421	29488E
605	530	30	91	46	245	530	570	4.0	—	—	80.9	29292E
685	567	51	144	72	257	575	630	5.0	—	—	216	29392E
765	608	74	199	100	272	615	690	8.0	—	—	435	29492E
635	556	33	99	55	259	555	595	4.0	—	—	97.5	29296E
705	590	51	144	72	270	595	650	5.0	—	—	224	29396E
810	638	81	216	108	280	645	730	8.0	—	—	543	29496E
654	574	33	99	55	268	575	615	4.0	—	—	101	292/500E
725	611	51	144	74	280	615	670	5.0	—	—	231	293/500E
830	661	81	216	107	290	670	750	8.0	—	—	559	294/500E
692	612	35	105	57	288	615	653	4.0	—	—	106	292/530E

NACHI-FUJIKOSHI CORP.

Tokyo Head Office : Shiodome Sumitomo Bldg. 17F 1-9-2 Higashi-shinbashi, Minato-ku, Tokyo 105-0021, JAPAN
Tel: +81-(0)3-5568-5111 Fax: +81-(0)3-5568-5206

Toyama Head Office : 1-1-1 Fujikoshi-Honmachi, Toyama 930-8511, JAPAN Tel: +81-(0)76-423-5111 Fax: +81-(0)76-493-5211

URL: <http://www.nachi-fujikoshi.co.jp>
E-mail: webmaster@nachi-fujikoshi.co.jp

Overseas Sales Companies

AMERICA

● **NACHI AMERICA INC. HEADQUARTERS**
17500 Twenty-Three Mile Road, Macomb, Michigan, 48044, U.S.A.
Tel: +1-586-226-5151 Fax: +1-888-383-8665
URL: <http://www.nachiamerica.com/>

INDIANA BRANCH
715 Pushville Road, Greenwood, Indiana, 46143, U.S.A.
Tel: +1-317-535-5527 Fax: +1-317-535-3659

WEST COAST BRANCH
12652 E. Alondra Blvd. Cerritos, California, 90703, U.S.A.
Tel: +1-562-802-0055 Fax: +1-562-802-2455

MIAMI BRANCH - LATIN AMERICA DIV.
2315 N.W. 107th Ave., Doral, Florida, 33172, U.S.A.
Tel: +1-305-591-0054/0059/2604
Fax: +1-305-591-3110

ATLANTA OFFICE
Six Concourse Parkway, Suite 2995 Atlanta, GA 30328, U.S.A.
Tel: +1-770-393-0270 Fax: +1-770-393-0271

● **NACHI ROBOTIC SYSTEMS INC.**
22285 Roethel Drive, Novi, Michigan, 48375, U.S.A.
Tel: +1-248-305-6545 Fax: +1-248-305-6542
URL: <http://www.nachirobotics.com/>

● **NACHI CANADA INC.**
89 Courtland Ave., Unit 2, Concord, Ontario, L4K 3T4, CANADA
Tel: +1-905-660-0088 Fax: +1-905-660-1146
URL: <http://www.nachicanada.com/>

● **NACHI MEXICANA, S.A. DE C.V.**
Urbina No 54, Parque Industrial Naucalpan, Naucalpan de Juarez, Estado de Mexico, C.P. 53370, MEXICO
Tel: +52-55-3604-0832 / 0842 / 0881
Fax: +52-55-3604-0882

NACHI ENGINEERING CENTER
1171A, Calle Julio Diaz Torre, Frace. Ciudad Industrial, Aguascalientes, C.P. 20290, MEXICO
Tel: +52-449-971-1689 Fax: +52-449-971-1689

EUROPE

● **NACHI EUROPE GmbH**
Bischofstrasse 99, 47809, Krefeld, GERMANY
Tel: +49-(0)2151-65046-0
Fax: +49-(0)2151-65046-90
URL: <http://www.nachi.de/>

SOUTH GERMANY OFFICE
Roetestrasse 18, 74321, Bietigheim-Bissingen, GERMANY
Tel: +49-(0)7142-77418-0
Fax: +49-(0)7142-77418-20

SPAIN BRANCH
Av. Alberto Alcocer 28, 1-A, 28036, Madrid, SPAIN
Tel: +34-(0)91-302-6440
Fax: +34-(0)91-383-9486

BARCELONA OFFICE
Josep Tarradellas, 58, 1-5, 08029 Barcelona, SPAIN
Tel: +34-(0)93-430-6247 Fax: +34-(0)93-419-0897

CZECH BRANCH
Mostni 73, Kolin 4, 28002, CZECH
Tel: +420-321-710-200 Fax: +420-321-710-200

U.K. BRANCH
Unit 7, Junction Six Industrial Estate, Electric Avenue, Birmingham B6 7JJ, U.K.
Tel: +44-(0)121-250-1890
Fax: +44-(0)121-250-1899

ASIA and OCEANIA

● **NACHI-FUJIKOSHI CORP.**
THAILAND REPRESENTATIVE OFFICE
Chai-ho Wongwaiwat Bldg. 889 Srinakarin Road, Samutprakarn, 10270, THAILAND
Tel: +66-2-748-7322~4 Fax: +66-2-748-7325

● **NACHI SINGAPORE PTE. LTD.**
No.2 Joo Koon Way, Jurong Town, Singapore 628943, SINGAPORE
Tel: +65-65587393 Fax: +65-65587371

VIETNAM OFFICE

614 Hong Bang Street, Ward 16, Dist 11, Ho Chi Minh City, VIETNAM
Tel: +84-8-9602-303 Fax: +84-8-9602-187

● **FUJIKOSHI-NACHI (MALAYSIA) SDN. BHD.**
No.17, Jalan USJ 21/3, 47630 UEP Subang Jaya, Selangor Darul Ehsan, MALAYSIA
Tel: +60-(0)3-80247900 Fax: +60-(0)3-80235884

● **P.T.NACHI INDONESIA**
Jl.H.R.Rasuna Said Kav.X-O Kuningan, Jakarta 12950, INDONESIA
Tel: +62-021-527-2841 Fax: +62-021-527-3029

● **那智不二越 (上海) 贸易有限公司 NACHI (SHANGHAI) CO.,LTD.**
Yitong Industry Zone 258, Fengmao Rd. Malu Town, Jiading, Shanghai 201801, CHINA
Tel: +86-(0)21-6915-2200
Fax: +86-(0)21-6915-5427

● **NACHI-FUJIKOSHI CORP.**
TAIPEI REPRESENTATIVE OFFICE
3F No.276, Sec3, Chung Ching N.Road, Taipei, TAIWAN
Tel: +886-(0)2-2596-0118
Fax: +886-(0)2-2596-5346

● **NACHI-FUJIKOSHI CORP.**
KOREA REPRESENTATIVE OFFICE
2F Dongsan Bldg. 276-4, Sungsu 2GA-3DONG Sungdong-Ku. Seoul 133-831, KOREA
Tel: +82-(0)2-469-2254 Fax: +82-(0)2-469-2264

● **NACHI-FUJIKOSHI CORP.**
INDIA REPRESENTATIVE OFFICE
A/9A, Sector-16, Noida-201301, Distt. Gautam Budh Nagar, U.P. INDIA
Tel: +91-120-4272257 Fax: +91-120-4272256

● **NACHI (AUSTRALIA) PTY. LTD.**
Unit 1, 23-29 South Street, Rydalmere, N.S.W, 2116, AUSTRALIA
Tel: +61-(0)2-9898-1511 Fax: +61-(0)2-9898-1678
URL: <http://www.nachi.com.au/>

Overseas Manufacturing Companies

AMERICA

● **NACHI TECHNOLOGY INC.**
713 Pushville Road, Greenwood, Indiana, 46143, U.S.A.
Tel: +1-317-535-5000 Fax: +1-317-535-8484
URL: <http://nachtech.com/>

● **NACHI MACHINING TECHNOLOGY CO.**
17500 Twenty-three Mile Road, Macomb, Michigan, 48044, U.S.A.
Tel: +1-586-263-0100 Fax: +1-586-263-4571
URL: <http://www.nachimtc.com/>

● **NACHI PRECISION NORTH CAROLINA INC.**
1836 Lindbergh Street Suite 400, Charlotte, North Carolina, 28208, U.S.A.
Tel: +1-704-391-1511 Fax: +1-704-391-1648

● **NACHI BRASIL LTDA.**
Avenida João XXIII, No.2330, Jardim São Pedro, Mogi das Cruzes, S.P., BRASIL, CEP 08830-000
Tel: +55-11-4793-8800 Fax: +55-11-4793-8870
URL: <http://www.nachi.com.br/>

EUROPE

● **NACHI CZECH S.R.O.**
Prumyslova 2732, 44001 Louny, CZECH
Tel: +420-415-930-930 Fax: +420-415-930-940

ASIA and OCEANIA

● **NACHI TECHNOLOGY (THAILAND) CO., LTD.**
5/5 M, 2, Rojana Industrial Estate Nongbua, Ban Khai, Rayong, 21120, THAILAND
Tel: +66-38-961-682 Fax: +66-38-961-683

● **NACHI INDUSTRIES PTE. LTD.**
No.2 Joo Koon Way, Jurong Town, Singapore 628943, SINGAPORE
Tel: +65-68613944 Fax: +65-68611153
URL: <http://www.nachinip.com.sg/>

● **NACHI PILIPINAS INDUSTRIES, INC.**
1st Avenue, Manalac Compound, Sta. Maria Industrial Estate, Bagumbayan, Taguig, Metro Manila, PHILIPPINES
Tel: +63-(0)2-838-3620 Fax: +63-(0)2-838-3623

MANILA OFFICE
Km23 East Service Road, Capang Muntinlupa, City Metro Manila, PHILIPPINES
Tel: +63-(0)2-850-0864 Fax: +63-(0)2-850-0864

● **建越工業股份有限公司 NACHI C.Y. CORP.**
No.109, Kao Young North Rd, Lung-Tan Hsin, Tao-Yuan Hsien, TAIWAN
Tel: +886-(0)3-471-7651 Fax: +886-(0)3-471-8402

● **东莞建越精密轴承有限公司 DONGGUAN NACHI C.Y. CORPORATION**
Dangyong Village, Hongmei Town Dongguan City, Guangdong, CHINA
Tel: +86-(0)769-8843-1300
Fax: +86-(0)769-8843-1330

● **那智不二越 (上海) 精密工具有限公司 NACHI (SHANGHAI) PRECISION TOOLS CO., LTD.**
Yitong Industry Zone 258, Fengmao Rd. Malu Town, Jiading, Shanghai 201801, CHINA
Tel: +86-(0)21-6915-7200
Fax: +86-(0)21-6915-7669

● **上海不二越精密轴承有限公司 SHANGHAI NACHI BEARINGS CO.,LTD.**
Yitong Industry Zone 258, Fengmao Rd. Malu Town, Jiading, Shanghai 201801, CHINA
Tel: +86-(0)21-6915-6200 Fax: +86-(0)21-6915-6202

● **耐锯(上海)精密刀具有限公司 SHANGHAI NACHI SAW CORP.**
Yitong Industry Zone 258, Fengmao Rd. Malu Town, Jiading, Shanghai 201801, CHINA
Tel: +86(0)21-6915-5899 Fax: +86(0)21-6915-5898

● **대성나찌 유압공업(주) DAESUNG-NACHI HYDRAULICS CO., LTD.**
289-22, Yousan-Dong, Yangsan-Si Kyungnam 626-800, KOREA
Tel: +82-(0)55-385-7891~3
Fax: +82-(0)55-384-3270

● **NACHI MOTHERSON TOOL TECHNOLOGY LTD.**
D-59-60, Sector-6, Noida-201301, Distt. Gautam Budh Nagar, U.P. INDIA
Tel: +91-120-425-8372 Fax: +91-120-425-8374